



HYGIENE

German quality hygiene brushes made by **haug**  **bürsten** 
 Made in Germany

Willkommen, welcome, bienvenue, bienvenidos

Als in Deutschland produzierender Bürstenhersteller stehen wir für höchste Qualität, innovative Fertigung und den Einsatz anspruchsvoller Rohstoffe. Unsere Hygienebürsten werden auf modernsten Maschinen mit größter Sorgfalt produziert – für zuverlässige Lösungen, die höchsten Ansprüchen gerecht werden.

As a brush manufacturer based in Germany, we are committed to the highest quality, innovative production and the use of premium raw materials. Our hygiene brushes are manufactured with the greatest care using the most modern machinery – delivering reliable solutions that meet the highest standards.

En tant que fabricant de brosses basé en Allemagne, nous sommes synonymes de qualité irréprochable, de procédés de fabrication innovants et d'utilisation de matières premières haut de gamme. Nos brosses hygiéniques sont fabriquées avec le plus grand soin sur des machines à la pointe de la technologie, pour offrir des solutions fiables qui répondent aux exigences les plus élevées.

Como fabricante de cepillos con sede en Alemania, somos sinónimo de máxima calidad, procesos de fabricación innovadores y el uso de materias primas de alta calidad. Nuestros cepillos higiénicos se fabrican con el mayor cuidado en máquinas de última generación, lo que garantiza soluciones fiables que satisfacen las exigencias más estrictas.



haug® bürsten
 Made in Germany

MATERIAL • MATERIAL • MATÉRIEL • MATERIAL LEGENDE • LEGEND • LÉGENDE • LEYENDA

Härte • stiffness • dureté • dureza

	weich • soft • doux • suave
	mittelhart • medium • moyen • media
	hart • hard • dur • dura

Faserende • bristles end • extrémité de la fibre • punta de las cerdas

	(1) ungeschlitztes Faserende • not flagged bristles • fibre non-fleuré • cerdas no despuntadas
	(2) geschlitztes Faserende • flagged bristles • fibre fleuré • cerdas despuntadas
	(3) gespitzenes Faserende • pointed bristles • fibre pointu • cerdas en punta

Temperaturbeständigkeit • temperature resistance • résistance des fibres à la température • resistencia a la temperatura

- Kälte- und Hitzebeständigkeit der Borsten gegen Heißluft in °C
- cold- and heat resistance of bristles against hot air in °C
- résistance des fibres au froid et à la chaleur contre air chaud en °C
- resistencia frío y al calor de las cerdas en aire caliente medido en °C

Abkürzungen für Materialien • abbreviations for materials • abréviations pour les matériels • abreviaciones de los materiales

ABS	ABS
ALU	Aluminium eloxiert • aluminium anodised • aluminium anodisé • aluminio anodizado
CO	Baumwolle • cotton • coton • algodón
FE	Stahl • lacquered metal • acier • acero
HM	Haarmischung • hair-mixture • mixture de poil • mezcla de pelo
INOX	Edelstahl • stainless steel • acier inox • acero inox
MET	Metall • metal • métal • metal
Nyl 6.0	Nylon 6.0
Nyl 6.6	Nylon 6.6
PA	Polyamid • polyamide • polyamide • poliamida
PBT	Polyester PBT
PE	Polyethylen • polyethylene • polyéthylène • polietilen
PEEK	Polyetheretherketon
PES	Polyester • polyester • polyester • poliéster
PET	Polyester • polyester • polyester • poliéster
PM	Polymex
POM	Polyoxymethylen • polyoxymethylene • polyoxyméthylène • polioximetileno
PP	Polypropylen • polypropylene • polypropylène • polipropileno
PP GF	Polypropylen Glasfaser • polypropylene fiberglass • polypropylène fibre de verre • polipropileno-fibra de vidrio
PS	Polystyrol • polystyrene • polystyrène • poliestireno
PVC	Polyvinylchlorid • polyvinyl chloride • polychlorure de vinyle • policloruro de vinilo
RH	Rosshaar • horsehair • crin de cheval • crin de caballo
TPE	Thermoplastische Elastomere • thermoplastic elastomers • thermoplastic élastomères • elastómeros termoplásticos
ZG	Lebensmittelgummi • food-approved rubber • caoutchouc alimentaire • goma alimentaria
ZK	Zellkautschuk • special rubber • caoutchouc cellulaire • goma especial
ZS	Zellschaum • rubber • caoutchouc • goma
VS	Viskose • viscose • viscosa • viscosa

LEGENDE • LEGEND • LÉGENDE • LEYENDA

Stielverbindung • handle fixation • fixation de manche • fijación del mango

(1) original haug 8-Kant Steck-Schraubensystem mit Überwurfmutter „einstecken – zuschrauben – 100%-iger Halt“

original haug 8 edges coupling system with collar „stick in – screw down – 100% professional fixation“

original haug octogonale système fixation avec bague „mettre – visser – 100% fixation“

sistema original haug octogonal de acoplamiento con collar “introdúcelo – atornillalo – 100% fijación profesional”

(2) deutsches Schraubgewinde • german screwing thread • filet de vis allemand • tornillo con rosca-hilo alemán

(6) Mopp-System ohne/mit Innengewinde • mop system without/with inner thread • système balais à franges sans/avec vis intérieur • sistema de mopa con/sin rosca-hilo interno

(3) amerikanisches Schraubgewinde • american screwing thread • filet de vis américain • tornillo con rosca-hilo americano

(4) Metall-Stielhalterung • metal handle fixation • vappui de manche en métal • fijación de mango en metal

(5) konisches Stecksystem • conical connector system • système de connecteur conique • sistema conector cónico



Hygiene-Standards • hygiene standards • normes d'hygiène • estándares de higiene

Im Kontakt mit Lebensmitteln unbedenklich • food grade approved • sans risque au contact des aliments • inocuo en contacto con los alimentos

HACCP Das HACCP (Hazard Analysis Critical Controlpoint)-Konzept, zu deutsch Gefährdungsanalyse und kritische Kontrollpunkte, dient als Leitlinie für Verfahrenspraxis und ist seit 1.1.2006 Bestandteil der EU-Verordnung. HACCP regelt u. a. LMHV-Vorgaben für Reinigung und Sauberkeit der Betriebsstätten, Anlagen und Geräte und Personalhygiene.

The HACCP (Hazard Analysis Critical Controlpoint) concept is used as guideline for procedure and is part of the EU law since 1.1.2006. HACCP regulates instructions of the LMHV for cleaning and cleanness of the working places, the plants, the utensils and personal hygiene.

HACCP (Hazard Analysis Critical Controlpoint) est un brouillon et une directrice pour les procédés et est un décret européen depuis 1.1.2006. HACCP régle instructions du LMHV pour le nettoyage et la propreté des lieux d'exploitation, des installations, des outils et du hygiène du personnel.

El concepto HACCP (Análisis de Peligros y Puntos Críticos de Control) es usado como guía para estos procedimientos y es parte de la ley de la EU desde 1.1.2006. HACCP entrega instrucciones de la LMHV para la limpieza y aseo de lugares de trabajo, plantas, utensilios e higiene personal.

Logo für Professionelle Hygiene-Bürstenwaren PHB gemäß Zulassung durch den Europäischen Bürstenverband F.E.I.B.P.

logo for Professional Hygiene Brushware PHB as approved from the European Brushware Federation F.E.I.B.P.

logo pour Brosserie d'Hygiène Professionnelle PHB selon directive de la Fédération Européenne de la Brosserie F.E.I.B.P.

logo de los Cepillos de Higiene Profesional, PHB, aprobados por la Federación Europea de Cepillos F.E.I.B.P.

Verpackungseinheit • packing unit • unité d'emballage • unidad de empaque

★ News 2026: neu • new • nouveaux • nuevo

6-17 WASSERSCHIEBER & ERSATZ- GUMMILIPPEN 300 - 720 mm



18-31 BODENGERÄTE



Besen 225-600 mm	19-25
Bodenschaber	29
Boden-Wischsysteme	30-31
Mopps und Wischbezüge	30-31
Wasserdurchlaufartikel	22 & 25
Wischer und Schrubber 200-600 mm	26-28

32-41 STIELE & ZUBEHÖR

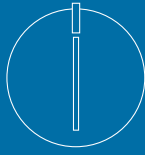

42-47 WAND- & DECKENGERÄTE



Geräteleisten und Zubehör	43-45
Pads und Padhalter	46-47
Staubbürsten und Spezialbürsten	45-46
Wasserdurchlaufartikel	46

48-51 SCHAUFELN & FAHREIMER & EIMER



Eimer	50
Fahreimer und Zubehör	51
Schaufeln	49-50

52-87 HANDGERÄTE



Autobürsten	61
Bäckerartikel	82-84
Fugenbürsten	64-65
Gläser- & Flaschenbürsten	76-78
Handbesen	53-55
Kehrgarnituren	56-57
Kehrgarnituren mit langem Stiel	58-59
Metzgerartikel	85-87
Pinsel	68-69
Rohr- & Schlauchbürsten	70-78
Schaufeln	56
Scheuerbürsten	66-67
Spülbürsten	79-81
Stielbürsten	60-63
Teppichkehrer	59
Waschbürsten	66-67
Wasserdurchlaufartikel	61

88-93 KÜCHENHELFER



Handschaufeln & Schöpfbehälter	91
Schaber	90
Schneidebretter & Zubehör	92
Schwämme	93
Spachteln	89-90

94-97 FENSTERREINIGER



98-109 SANITÄR & WC

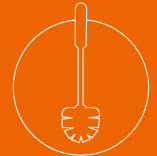

Nagelbürsten	99-100
WC- und Sanitärbürsten	101-105
WC-Garnituren	106-109

110-139 SPEZIAL-SORTIMENTE



ANTI BAC	130-133
ESD	134-139
„in-up“	112-115
METAL DETECT BASIC & METAL DETECT PREMIUM	120-129
RECYCLED. FOR NATURE.	116-119

6-17 RUBBER SQUEEGEES & REFILL RUBBERS 300 - 720 mm

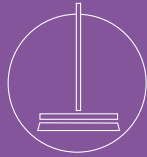

18-31 FLOOR ARTICLES

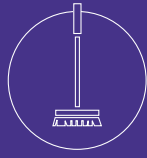

brooms 225-600 mm	19-25
floor scrapers	29
mopping systems	30-31
waterchannel articles	22 & 25
wipers and scrubs 200-600 mm	26-28

32-41 HANDLES & ACCESSORIES

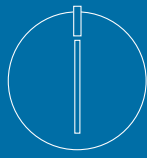

42-47 WALL & CEILING ARTICLES



dusters	45-46
equipment borders and accessories	43-45
pads and pad holders	46-47
waterchannel articles	46

48-51 SHOVELS & TROLLEYS & BUCKETS



buckets	50
shovels	49-50
trolleys and accessories	51

52-87 HAND ARTICLES



bakery articles and tools	82-84
butcher articles and tools	85
car brushes	61
carpet sweepers	59
churn-brushes	60-63
dishwashing-brushes	79-81
dustpans	56
dustpan-sets	56-57
glass- and bottle-brushes	76-78
hand-brushes	53-55
hand-scrub-brushes	66-67
joint-brushes	64-65
lobby dustpan-sets	58-59
pastry-brushes	68-69
scrubbing-brushes	66-67
tube- and hose-brushes	70-78
waterchannel articles	61

88-93 KITCHEN GADGETS



cutting boards & accessories	92
scoops	91
scrapers	90
spatulas	89-90
sponges	93

94-97 WINDOW CLEANERS



98-109 SANITARY & TOILET

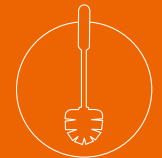

nail-brushes	99-100
toilet-brushes	101-105
toilet-sets	106-109

110-139 SPECIAL ASSORTMENTS



ANTI BAC	130-133
ESD	134-139
„in-up“	112-115
METAL DETECT BASIC & METAL DETECT PREMIUM	120-129
RECYCLED. FOR NATURE.	116-119

6-17 RACLETTES SOL & RECHANGES 300 - 720 mm



18-31 ÉQUIPEMENT DE SOL



balais 225-600 mm	19-25
franges	30-31
balais à passage d'eau	22 & 25
frottoirs 200-600 mm	26-28
raclettes sol	29
systèmes de nettoyage des sols	30-31

32-41 MANCHES & ACCESSOIRES

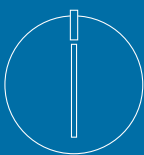

42-47 ÉQUIPEMENT AU MUR & AU PLAFOND

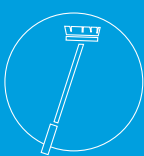

brosses à passage d'eau	46
époussettes	45-46
pads et porte pads	46-47
barres d'outils et accessoires	43-45

48-51 PÈLES & CHARIOTS & SEAUX



chariots d'entretien et accessoires	51
pèles	49-50
seaux	50

52-87 OUTILS MANUELS



balais mécaniques	59
balayettes	53-55
bouchers: brosses et outils	85-87
boulangers: balais et brosses	82-84
brosses à main	66-67
brosses à manche	60-63
brosses à vaisselle	79-81
brosse à passage d'eau	61
brosses joints	64-65
brosses pour bouteilles et verres	76-78
brosses voitures	61
écouvillons	70-78
pelles	56
pelles et balayettes	56-57
pelles et balayettes avec manche long	58-59
pinceaux	68-69

88-93 UTENSILES DE CUISINE



éponges	93
pelles à main & louches	91
planches à découper & accessoires	92
racloirs	90
spatules	89-90

94-97 RACLETTES VITRES



98-109 SANITAIRE & WC



brosses à ongles	99-100
brosses à wc et sanitaires	101-105
ensembles wc	106-109

110-139 GAMMES SPÉCIALES



ANTI BAC	130-133
ESD	134-139
„in-up“	112-115
METAL DETECT BASIC & METAL DETECT PREMIUM	120-129
RECYCLED. FOR NATURE.	116-119

6-17 HARAGANES DE GOMA Y GOMAS DE REPUASTO 300 - 720 mm



18-31 ARTICULOS DE PISO

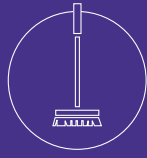

escobas y escobillones 225-600 mm	19-25
escobillones con paso de agua	22 & 25
escobillones, esquineros y cepillos para fregar 200-600 mm	26-28
raspadores de piso	29
sistemas de mopa	30-31

32-41 MANGOS Y ACCESORIOS

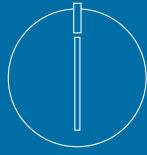

42-47 ARTICULOS DE PARED Y TECHO



cepillos-plumeros	45-46
cepillos con paso de agua	46
rieles-organizadores para equipos y accesorios	43-45
pads y porta pads	46-47

48-51 PALAS Y CARROS Y BALDES



baldes	50
carros y accesorios	51
palas	49-50

52-87 ARTICULOS DE MANO



barredoras	59
brochas para pastelerías y parrillas	68-69
cepillos articulados	64-65
cepillos con mango	60-63
cepillos con paso de agua	61
cepillos de mano	53-55
cepillos de mano para fregar	66-67
cepillos para lavaplatos	79-81
cepillos para vehículos	61
cepillos y herramientas para carnicerías	85-87
escobas y cepillos para panaderías	82-84
hisopos para cristalería y botellas	76-78
hisopos para mangueras y tubos	70-78
palas de mano	56
sets de pala + cepillo	56-57
sets de pala basculante + escoba con mango largo	58-59

88-93 UTENSILIOS DE COCINA



espátulas	89-90
esponjas	93
porúñas de mano	91
raspadores	90
tablas de corte	91-92

94-97 LIMPIA-VENTANAS



98-109 SANITARIO Y WC

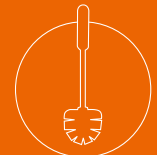

cepillos sanitarios y para w.c	101-105
escobillas de uñas	99-100
sets para w.c.	106-109

110-139 PRODUCTOS ESPECIALES

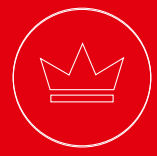

ANTI BAC	130-133
ESD	134-139
„in-up“	112-115
METAL DETECT BASIC & METAL DETECT PREMIUM	120-129
RECYCLED. FOR NATURE.	116-119

BESTÄNDIGKEITEN DER VERWENDETEN MATERIALIEN • RESISTANCES OF USED MATERIALS • RÉSISTANCES DES MATÉRIAUX UTILISÉS • RESISTENCIA DE LOS MATERIALES USADOS

Aluminium	Fiberglas	Nylon 6.0 / PA 6	Nylon 6.6 / PA 6.6	PEEK	Polyester PBT PERLON	Polyester PET	Polymex	PP	PS	Zellkautschuk Special rubber Caoutchouc cellulaire Goma especial ZK	Lebensmittelgummi food-approved rubber Caoutchouc alimentaire Goma alimentaria ZG	TPE
-----------	-----------	------------------	--------------------	------	----------------------	---------------	---------	----	----	---	---	-----

Thermische Beständigkeiten • Thermal resistances • Resistances thermiques • Resistencia térmica

Hitzebeständigkeit in °C / Heißluft Heat resistance / hot air Résistance à la chaleur / air chaud Resistencia al calor / Aire caliente	100	75	100	130	250	140	130	80	80	85	85	75	121
---	-----	----	-----	-----	-----	-----	-----	----	----	----	----	----	-----

Chemische Beständigkeiten (in üblichen Anwendungskonzentrationen) • Chemical resistances (in used concentration) • Résistances chimiques (en concentration d'application) • Resistencia química (en concentraciones usadas)

Wässrige Alkalien Diluted alkalis Alcalis aqueux Alcalis diluidos	■	■	■	■	■	■	■	■	■	■	■	■	■
Verdünnte organische Säuren Diluted organic acids Acides organiques dilués Ácidos orgánicos diluidos	■	■	■	■	■	■	■	■	■	■	■	■	■
Verdünnte mineralische Säuren Diluted mineral acids Acides minéraux dilués Ácidos minerales diluidos	■	■	■	■	■	■	■	■	■	■	■	■	■
Organische Lösungsmittel Organic solvents Détergents organiques Solventes orgánicos	■	■	■	■	■	■	■	■	■	■	■	■	■
Schwache Laugen Weak lyes Lessives faibles Lejías débiles	■	■	■	■	■	■	■	■	■	■	■	■	■
Aceton Acetone Acétone Acetona	■	■	■	■	■	■	■	■	■	■	■	■	■
Alkohole Alcohols Alcools Alcoholes	■	■	■	■	■	■	■	■	■	■	■	■	■
Mineralische Schmierstoffe / Benzin Mineral lubricants / petrol Lubrifiants minéraux / benzine Lubricantes minerales / bencina	■	■	■	■	■	■	■	■	■	■	■	■	■

Beständig Resistant Résistant Resistente	■
Bedingt beständig Partly resistant Limité résistant Parcialmente resistente	■
Nicht beständig Non resistant Pas résistant No resistente	■

- Die Angaben sind Richtwerte und basieren auf Werkstoffdaten der Materialhersteller. Die Werte sind beeinflussbar durch Arbeitsbedingungen und Umgebungseinflüsse und befreien den Anwender nicht von eigenen Prüfungen und Versuchen.
- All informations are guide numbers and are based on the informations of our material suppliers. The values are influenced by working conditions and surroundings and don't release the user from own examinations and tests.
- Toutes les informations sont valeurs indicatives et basent sur les informations des fournisseurs des matériaux. Les valeurs sont influençables sur les conditions de travail et les ambiances et ne libèrent pas l'utilisateur des examens et essais.
- Todas las informaciones son valores de referencia y están basadas en la información entregada por nuestros proveedores de materiales. Los valores están influenciados por condiciones de trabajo y de ambiente y no liberan al usuario de hacer sus propias examinaciones y pruebas.

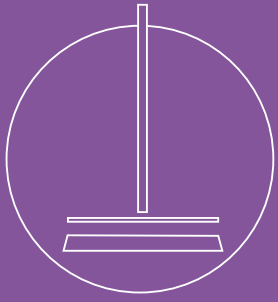

**WASSERSCHIEBER
RUBBER SQUEEGEES
RACLETTES SOL
HARAGANES DE GOMA
300 - 720 MM**

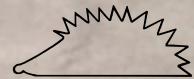

**ANWENDUNGSVIDEO
APPLICATION VIDEO
VIDÉO DE DÉMONSTRATION
VÉDEO DE APLICACIÓN**



420 MM

8790

Wasserschieber zweilippig
rubber squeegee double bladed
raclette sol bilame
haragane de goma doble



Körper · block · corps · cuerpo:	PP GF
Maße · size · mesure · medidas/mm:	420 x 35 x 85
Besatzhöhe · rubber trim · taille garniture · altura goma/mm:	30
Besatzmaterial · rubber quality · matériel · material:	ZK

-20-85°C



HACCP



420 MM

87900

Wasserschieber zweilippig
rubber squeegee double bladed
raclette sol bilame
haragane de goma doble



Körper · block · corps · cuerpo:	PP GF
Maße · size · mesure · medidas/mm:	420 x 35 x 85
Besatzhöhe · rubber trim · taille garniture · altura goma/mm:	30
Besatzmaterial · rubber quality · matériel · material:	ZG

-20-80°C



HACCP



87900



FC87901



FC87902



FC87903



FC87904



FC87905



FC87907

420 MM

8796G

Wasserschieber mit
Wechselprofil zweilippig
rubber squeegee with change-
able rubber double bladed
raclette sol avec caoutchouc
interchangeable bilame
haragane de goma doble
recambiable



Körper · block · corps · cuerpo:	PP GF
Maße · size · mesure · medidas/mm:	420 x 35 x 85
Besatzhöhe · rubber trim · taille garniture · altura goma/mm:	30
Besatzmaterial · rubber quality · matériel · material:	ZK

-20-85°C



HACCP

**87960G**

Wasserschieber mit
Wechselprofil zweilippig
rubber squeegee with changeable
rubber double bladed
raclette sol avec caoutchouc
interchangeable bilame
haragane de goma doble
recambiable



Körper · block · corps · cuerpo:	PP GF
Maße · size · mesure · medidas/mm:	420 x 35 x 85
Besatzhöhe · rubber trim · taille garniture · altura goma/mm:	30
Besatzmaterial · rubber quality · matériel · material:	ZG

-20-80°C



HACCP



WASSERSCHIEBER · RUBBER SQUEEGEES · RACLETTES SOL · HARAGANES DE GOMAS

8796

Wasserschieber mit
Wechselprofil einlippig
rubber squeegee with change-
able rubber **single bladed**
raclette sol avec caoutchouc
interchangeable **unilame**
haragane de goma simple
recambiable



Körper · block · corps · cuerpo:	PP GF
Maße · size · mesure · medidas/mm:	420 x 35 x 85
Besatzhöhe · rubber trim · taille garniture · altura goma/mm:	30
Besatzmaterial · rubber quality · matériel · material:	ZK

-20-85°C



HACCP



420 MM



 ANWENDUNGSVIDEO
APPLICATION VIDEO
VIDÉO DE DÉMONSTRATION
VÉDEO DE APLICACIÓN



87960

Wasserschieber mit
Wechselprofil einlippig
rubber squeegee with change-
able rubber **single bladed**
raclette sol avec caoutchouc
interchangeable **unilame**
haragane de goma simple
recambiable



Körper · block · corps · cuerpo:	PP GF
Maße · size · mesure · medidas/mm:	420 x 35 x 85
Besatzhöhe · rubber trim · taille garniture · altura goma/mm:	30
Besatzmaterial · rubber quality · matériel · material:	ZG

-20-80°C



HACCP



87960



FC87961



FC87962



FC87963



FC87964



FC87965



FC87967

420 MM

8794

Gelenk-Wasserschieber
zweilippig
swivel rubber squeegee
double bladed
raclette sol bilame
pivotante
haragane de goma **doble**
con rosca giratoria



Körper · block · corps · cuerpo:	PP GF
Maße · size · mesure · medidas/mm:	420 x 53 x 100
Besatzhöhe · rubber trim · taille garniture · altura goma/mm:	30
Besatzmaterial · rubber quality · matériel · material:	ZK

-20-85°C



HACCP



420 MM

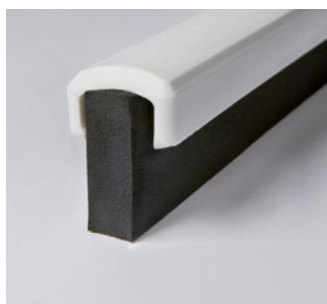
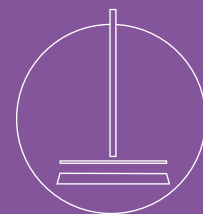

**EINLIPPIG
SINGLE BLADED
UNILAME
GOMA SIMPLE**

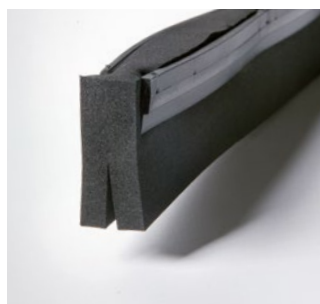

**ZWEILIPPIG
DOUBLE BLADED
BILAME
GOMA DOBLE**



Zur Montage Leiste mit Seife oder Spülmittel schmieren und in den Körper einziehen

Grease strip with soap or detergent and pull it into the block for assembling

Pour le montage lubrifiez le bar avec du savon ou détergent et tirez-le dans le corps

Lubrica la banda con jabón o detergente e insértalo en el cuerpo para montarlo

87940

**Gelenk-Wasserschieber
zweilippig
swivel rubber squeegee
double bladed
raclette sol bilame
pivotante
haragane de goma doble
con rosca giratoria**



Körper · block · corps · cuerpo:	PP GF
Maße · size · mesure · medidas/mm:	420 x 53 x 100
Besatzhöhe · rubber trim · taille garniture · altura goma/mm:	30
Besatzmaterial · rubber quality · matériel · material:	ZG

-20-80°C



HACCP



87940



87941



87942



87943



87944

420 MM

8783

**Gelenk-Wasserschieber mit
Wechselprofil einlippig
swivel rubber squeegee
with changeable rubber
single bladed
raclette sol pivotante avec
caoutchouc interchangeable
unilame
haragane de goma simple
recambiable con rosca giratoria**

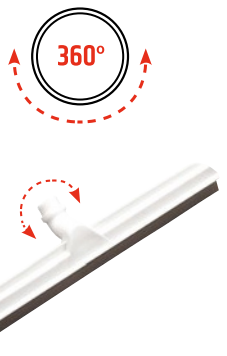

Körper · block · corps · cuerpo:	PP GF
Maße · size · mesure · medidas/mm:	420 x 53 x 100
Besatzhöhe · rubber trim · taille garniture · altura goma/mm:	30
Besatzmaterial · rubber quality · matériel · material:	ZK

-20-85°C



HACCP















420 MM









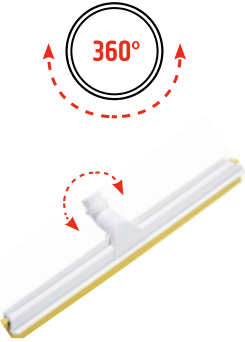

WASSERSCHIEBER · RUBBER SQUEEGEES · RACLETTES SOL · HARAGANES DE GOMAS

539	
Wasserschieber zweilippig rubber squeegee double bladed raclette sol bilame haragane de goma doble	
Körper · block · corps · cuerpo:	MET
Maße · size · mesure · medidas/mm:	450 x 27 x 100
Besatzhöhe · rubber trim · taille garniture · altura goma/mm:	30
Besatzmaterial · rubber quality · matériel · material:	ZS
-20-60°C  	

450 MM

E1108790		Körper · block · corps · cuerpo:	PP GF			
Wasserschieber Körper rubber squeegee case corp raclette sol cuerpo de haragane de goma		Maße · size · mesure · medidas/mm:	400 x 35 x 60			
-20-140°C   HACCP  						
 E1108790-000	 E1108790-084	 E1108790-044	 E1108790-074	 E1108790-014	 E1108790-005	 E1108790-080

400 MM

87830		Körper · block · corps · cuerpo:	PP GF	
Gelenk-Wasserschieber mit Wechselprofil einlippig swivel rubber squeegee with changeable rubber single bladed raclette sol pivotante avec caoutchouc interchangeable unilame haragane de goma simple recambiable con rosca giratoria		Maße · size · mesure · medidas/mm:	420 x 53 x 100	
-20-80°C   HACCP  				
 87830	 87831	 87832	 87833	 87834

420 MM

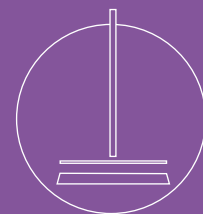

620 MM

8780		Körper · block · corps · cuerpo:	PP GF
		Maße · size · mesure · medidas/mm:	620 x 35 x 110
Wasserschieber zweilippig rubber squeegee double bladed raclette sol bilame haragane de goma doble		Besatzhöhe · rubber trim · taille garniture · altura goma/mm:	30
		Besatzmaterial · rubber quality · matériel · material:	ZK
		-20-85°C	 HACCP  10

620 MM

87800		Körper · block · corps · cuerpo:	PP GF
		Maße · size · mesure · medidas/mm:	620 x 35 x 110
Wasserschieber zweilippig rubber squeegee double bladed raclette sol bilame haragane de goma doble		Besatzhöhe · rubber trim · taille garniture · altura goma/mm:	30
		Besatzmaterial · rubber quality · matériel · material:	ZG
		-20-80°C	 HACCP  HACCP   10







						
87800	FC87801	FC87802	FC87803	FC87804	FC87805	FC87807

620 MM



8786G		Körper · block · corps · cuerpo:	PP GF
		Maße · size · mesure · medidas/mm:	620 x 35 x 110
Wasserschieber mit Wechselprofil zweilippig rubber squeegee with change- able rubber double bladed raclette sol avec caoutchouc interchangeable bilame haragane de goma doble recambiable		Besatzhöhe · rubber trim · taille garniture · altura goma/mm:	30
		Besatzmaterial · rubber quality · matériel · material:	ZK
		-20-85°C	 HACCP  10

620 MM





87860G		Körper · block · corps · cuerpo:	PP GF
		Maße · size · mesure · medidas/mm:	620 x 35 x 110
Wasserschieber mit Wechselprofil zweilippig rubber squeegee with change- able rubber double bladed raclette sol avec caoutchouc interchangeable bilame haragane de goma doble recambiable		Besatzhöhe · rubber trim · taille garniture · altura goma/mm:	30
		Besatzmaterial · rubber quality · matériel · material:	ZG
		-20-80°C	 HACCP  HACCP   5







						
87860G	FC87861G	FC87862G	FC87863G	FC87864G	FC87865G	FC87867G

WASSERSCHIEBER · RUBBER SQUEEGEES · RACLETTES SOL · HARAGANES DE GOMAS



8786		Körper · block · corps · cuerpo:	PP GF
		Maße · size · mesure · medidas/mm:	620 x 35 x 110
Wasserschieber mit Wechselprofil einlippig rubber squeegee with changeable rubber single bladed raclette sol avec caoutchouc interchangeable unilame haragane de goma simple recambiable		Besatzhöhe · rubber trim · taille garniture · altura goma/mm:	30
		Besatzmaterial · rubber quality · matériel · material:	ZK
		-20-85°C	 HACCP  10

620 MM

87860		Körper · block · corps · cuerpo:	PP GF
		Maße · size · mesure · medidas/mm:	620 x 35 x 110
Wasserschieber mit Wechselprofil einlippig rubber squeegee with changeable rubber single bladed raclette sol avec caoutchouc interchangeable unilame haragane de goma simple recambiable		Besatzhöhe · rubber trim · taille garniture · altura goma/mm:	30
		Besatzmaterial · rubber quality · matériel · material:	ZG
		-20-80°C	 HACCP   5

						
87860	FC87861	FC87862	FC87863	FC87864	FC87865	FC87867

620 MM

8784		Körper · block · corps · cuerpo:	PP GF
		Maße · size · mesure · medidas/mm:	620 x 53 x 100
Gelenk-Wasserschieber zweilippig swivel rubber squeegee double bladed raclette sol bilame pivotante haragane de goma doble con rosca giratoria		Besatzhöhe · rubber trim · taille garniture · altura goma/mm:	30
		Besatzmaterial · rubber quality · matériel · material:	ZK
		-20-85°C	 HACCP  5

620 MM

87840		Körper · block · corps · cuerpo:	PP GF
		Maße · size · mesure · medidas/mm:	620 x 53 x 100
Gelenk-Wasserschieber zweilippig swivel rubber squeegee double bladed raclette sol bilame pivotante haragane de goma doble con rosca giratoria		Besatzhöhe · rubber trim · taille garniture · altura goma/mm:	30
		Besatzmaterial · rubber quality · matériel · material:	ZG
		-20-80°C	 HACCP   5

				
87840	87841	87842	87843	87844

620 MM

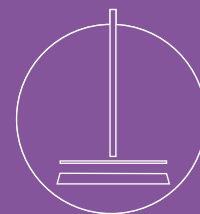

8785

Gelenk-Wasserschieber mit Wechselprofil einlippig
swivel rubber squeegee with changeable rubber single bladed
raclette sol pivotante avec caoutchouc interchangeable unilame
haragane de goma simple recambiable con rosca giratoria



Körper · block · corps · cuerpo:	PP GF
Maße · size · mesure · medidas/mm:	620 x 53 x 100
Besatzhöhe · rubber trim · taille garniture · altura goma/mm:	30
Besatzmaterial · rubber quality · matériel · material:	ZK

-20-85°C



HACCP



5396

Wasserschieber zweilippig
rubber squeegee double bladed
raclette sol bilame
haragane de goma doble



Körper · block · corps · cuerpo:	MET
Maße · size · mesure · medidas/mm:	550 x 22 x 105
Besatzhöhe · rubber trim · taille garniture · altura goma/mm:	30
Besatzmaterial · rubber quality · matériel · material:	ZS

-20-60°C



620/550 MM

8798

Gelenk-Wasserschieber mit Wechselprofil einlippig
swivel rubber squeegee with changeable rubber single bladed
raclette sol pivotante avec caoutchouc interchangeable unilame
haragane de goma simple recambiable con rosca giratoria



Körper · block · corps · cuerpo:	PP GF
Maße · size · mesure · medidas/mm:	720 x 53 x 100
Besatzhöhe · rubber trim · taille garniture · altura goma/mm:	30
Besatzmaterial · rubber quality · matériel · material:	ZK

-20-85°C



HACCP



720 MM

E1108780

Wasserschieber Körper
rubber squeegee case
corp raclette sol
cuerpo de haragane de goma



Körper · block · corps · cuerpo:	PP GF
Maße · size · mesure · medidas/mm:	600 x 32 x 70

-20-140°C



HACCP



600 MM



E1108780-000



E1108780-084



E1108780-044



E1108780-074



E1108780-014



E1108780-005



E1108780-080

WASSERSCHIEBER · RUBBER SQUEEGEES · RACLETTES SOL · HARAGANES DE GOMAS



**ANGESPRITZTE LIPPE
BI-INJECTED LIP
MONOLAME ÉLASTOMÈRE
LABIO BI-INJECTADO**

<h2>8788</h2> <p>Wasserschieber mit angespritzter Lippe rubber squeegee with bi-injected lip raclette sol avec monolame élastomère haragane de goma de labio bi-injectado</p>		Körper · block · corps · cuerpo: PP GF	Maße · size · mesure · medidas/mm: 560 x 43 x 85
		Besatzhöhe · rubber trim · taille garniture · altura goma/mm: 22	Besatzmaterial · rubber quality · matériel · material: TPE TPE: abriebfest · abrasionproof · résistant à l'abrasion · resistente a la abrasión
		-20-121°C HACCP 5	
87880 87881 87882 87883 87884 87887			

560 MM

<h2>8789</h2> <p>Wasserschieber mit angespritzter Lippe rubber squeegee with bi-injected lip raclette sol avec monolame élastomère haragane de goma de labio bi-injectado</p>		Körper · block · corps · cuerpo: PP	Maße · size · mesure · medidas/mm: 300 x 40 x 106
		Besatzhöhe · rubber trim · taille garniture · altura goma/mm: 25	Besatzmaterial · rubber quality · matériel · material: TPE TPE: abriebfest · abrasionproof · résistant à l'abrasion · resistente a la abrasión
		-20-121°C HACCP 5	
87890 FC87891 FC87892 FC87893 FC87894			

300 MM

ERSATZ-GUMMILIPPEN • REFILL RUBBERS • RECHANGES • GOMAS DE REPUESTO 420 - 720 MM



**EINLIPPIG
SINGLE BLADED
UNILAME
GOMA SIMPLE**

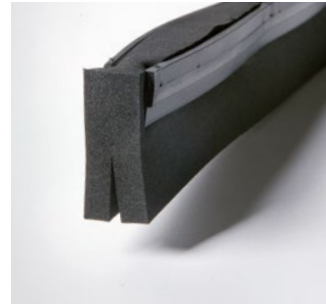

**ZWEILIPPIG
DOUBLE BLADED
BILAME
GOMA DOBLE**

EINLIPPIG • SINGLE BLADED • UNILAME • SIMPLE

620 MM

8787

Ersatz-Gummilippe
einlippig
refill rubber **single bladed**
rechange caoutchouc **unilame**
goma de repuesto **simple**



Körper • block • corps • cuerpo:	PP
Maße • size • mesure • medidas/mm:	620 x 20 x 45
Besatzhöhe • rubber trim • taille garniture • altura goma/mm:	30
Besatzmaterial • rubber quality • matériel • material:	ZK

-20-85°C HACCP



87870

Ersatz-Gummilippe
einlippig
refill rubber **single bladed**
rechange caoutchouc **unilame**
goma de repuesto **simple**

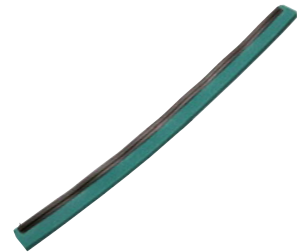

Körper • block • corps • cuerpo:	PP
Maße • size • mesure • medidas/mm:	620 x 20 x 45
Besatzhöhe • rubber trim • taille garniture • altura goma/mm:	30
Besatzmaterial • rubber quality • matériel • material:	ZG

-20-80°C



HACCP



620 MM



87870



87871

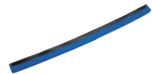

87872

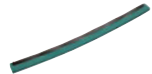

87873



87874



87875



87877

420 MM

8797

Ersatz-Gummilippe
einlippig
refill rubber **single bladed**
rechange caoutchouc **unilame**
goma de repuesto **simple**



Körper • block • corps • cuerpo:	PP
Maße • size • mesure • medidas/mm:	420 x 20 x 45
Besatzhöhe • rubber trim • taille garniture • altura goma/mm:	30
Besatzmaterial • rubber quality • matériel • material:	ZK

-20-85°C HACCP



ERSATZ-GUMMILIPPEN · REFILL RUBBERS · RECHANGES · GOMAS DE REPUESTO

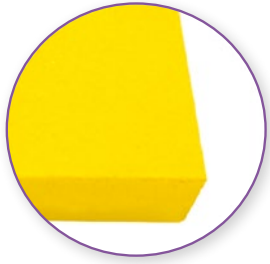











**EINLIPPIG
SINGLE BLADED
CAOUTCHOUC MONOLAME
REPUESTO SIMPLE**

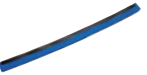

**ZWEILIPPIG
DOUBLE BLADED
CAOUTCHOUC BILAME
REPUESTO DOBLE**







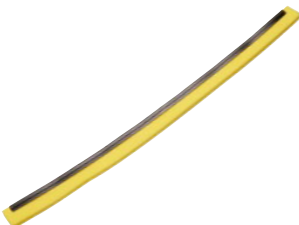

EINLIPPIG · SINGLE BLADED · UNILAME · SIMPLE

87970		Körper · block · corps · cuerpo:	PP
		Maße · size · mesure · medidas/mm:	420 x 20 x 45
Ersatz-Gummilippe einlippig refill rubber single bladed rechange caoutchouc unilame goma de repuesto simple		Besatzhöhe · rubber trim · taille garniture · altura goma/mm:	30
		Besatzmaterial · rubber quality · matériel · material:	ZG
		-20-80°C	 HACCP  
			
87970	87971	87972	87973
			
87974	87975	87977	

420 MM

8799		Körper · block · corps · cuerpo:	PP
		Maße · size · mesure · medidas/mm:	720 x 20 x 45
Ersatz-Gummilippe einlippig refill rubber single bladed rechange caoutchouc unilame goma de repuesto simple		Besatzhöhe · rubber trim · taille garniture · altura goma/mm:	30
		Besatzmaterial · rubber quality · matériel · material:	ZK
		-20-85°C	HACCP 

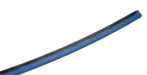
720 MM

87990		Körper · block · corps · cuerpo:	PP
		Maße · size · mesure · medidas/mm:	720 x 20 x 45
Ersatz-Gummilippe einlippig refill rubber single bladed rechange caoutchouc unilame goma de repuesto simple		Besatzhöhe · rubber trim · taille garniture · altura goma/mm:	30
		Besatzmaterial · rubber quality · matériel · material:	ZG
		-20-80°C	 HACCP  
			
87990	87991	87992	87993
			
87994			

720 MM

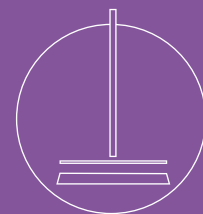









ZWEILIPPIG · DOUBLE BLADED · BILAME · DOBLE

620 MM

8787G		Körper · block · corps · cuerpo:	PP
		Maße · size · mesure · medidas/mm:	620 x 20 x 45
Ersatz-Gummilippe zweilippig refill rubber double bladed rechange caoutchouc bilame goma de repuesto doble		Besatzhöhe · rubber trim · taille garniture · altura goma/mm:	30
		Besatzmaterial · rubber quality · matériel · material:	ZK
		-20-85°C	HACCP 

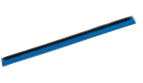
620 MM



87870G		Körper · block · corps · cuerpo:	PP
		Maße · size · mesure · medidas/mm:	620 x 20 x 45
Ersatz-Gummilippe zweilippig refill rubber double bladed rechange caoutchouc bilame goma de repuesto doble		Besatzhöhe · rubber trim · taille garniture · altura goma/mm:	30
		Besatzmaterial · rubber quality · matériel · material:	ZG
		-20-80°C	HACCP  







 87870G	 87871G	 87872G	 87873G	 87874G	 87875G	 87877G
--	--	--	--	---	--	--

420 MM

8797G		Körper · block · corps · cuerpo:	PP
		Maße · size · mesure · medidas/mm:	420 x 20 x 45
Ersatz-Gummilippe zweilippig refill rubber double bladed rechange caoutchouc bilame goma de repuesto doble		Besatzhöhe · rubber trim · taille garniture · altura goma/mm:	30
		Besatzmaterial · rubber quality · matériel · material:	ZK
		-20-85°C	HACCP 

420 MM

87970G		Körper · block · corps · cuerpo:	PP
		Maße · size · mesure · medidas/mm:	420 x 20 x 45
Ersatz-Gummilippe zweilippig refill rubber double bladed rechange caoutchouc bilame goma de repuesto doble		Besatzhöhe · rubber trim · taille garniture · altura goma/mm:	30
		Besatzmaterial · rubber quality · matériel · material:	ZG
		-20-80°C	HACCP  

 87970G	 87971G	 87972G	 87973G	 87974G	 87975G	 87977G
--	--	--	--	---	--	--

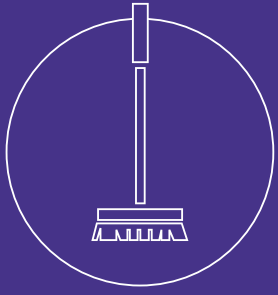

**BODENGERÄTE
FLOOR ARTICLES
ÉQUIPEMENT DE SOL
ARTICULOS DE PISO**



BESEN WEICH · BROOMS SOFT · BALAIS DOUX · ESCOBAS SUAVES

8721

Besen
broom
balai
escoba



Körper · block · corps · cuerpo: PP
 Maße · size · mesure · medidas/mm: 320 x 110 x 115
 Besatzhöhe · bristle trim ·
 taille garniture · altura cerda/mm: 50
 Besatzmaterial · bristle · matériel · material: PBT Ø 0,25

-20-140°C



HACCP



87210



FC87211



FC87212



FC87213



FC87214



FC87215



FC87217

320 MM

8721U

Besen
broom
balai
escoba



Körper · block · corps · cuerpo: PP
 Maße · size · mesure · medidas/mm: 320 x 110 x 115
 Besatzhöhe · bristle trim ·
 taille garniture · altura cerda/mm: 50
 Besatzmaterial · bristle · matériel · material: PBT Ø 0,25

-20-140°C



HACCP



87210U



FC87211U



FC87212U



FC87213U



FC87214U



FC87215U



FC87217U

320 MM

8751

Besen
broom
balai
escoba



Körper · block · corps · cuerpo: PP
 Maße · size · mesure · medidas/mm: 330 x 100 x 110
 Besatzhöhe · bristle trim ·
 taille garniture · altura cerda/mm: 55
 Besatzmaterial · bristle · matériel · material: PBT Ø 0,25

-20-140°C



HACCP



87510



FC87511



FC87512



FC87513



FC87514



FC87515



FC87517

330 MM

8751U

Besen
broom
balai
escoba



Körper · block · corps · cuerpo: PP
 Maße · size · mesure · medidas/mm: 330 x 100 x 110
 Besatzhöhe · bristle trim ·
 taille garniture · altura cerda/mm: 55
 Besatzmaterial · bristle · matériel · material: PBT Ø 0,25

-20-140°C



HACCP



87510U



FC87511U



FC87512U



FC87513U



FC87514U



FC87515U



FC87517U

330 MM

BESEN WEICH · BROOMS SOFT · BALAIS DOUX · ESCOBAS SUAVES



8883

Großraumbesen
great-room-broom
balai pour grands espaces
escobillone para grandes
espacios



Körper · block · corps · cuerpo:	PP
Maße · size · mesure · medidas/mm:	415 x 70 x 100
Besatzhöhe · bristle trim · taille garniture · altura cerda/mm:	45/50
Besatzmaterial · bristle · matériel · material:	PBT Ø 0,50/0,25



-20-140°C



HACCP



415 MM

8882

Großraumbesen
great-room-broom
balai pour grands espaces
escobillone para grandes
espacios



Körper · block · corps · cuerpo:	PP
Maße · size · mesure · medidas/mm:	415 x 90 x 105
Besatzhöhe · bristle trim · taille garniture · altura cerda/mm:	50
Besatzmaterial · bristle · matériel · material:	PBT Ø 0,25



-20-140°C



HACCP



415 MM



88820



FC88821



FC88822



FC88823



FC88824



FC88825



FC88827

8882U

Großraumbesen
great-room-broom
balai pour grands espaces
escobillone para grandes
espacios



Körper · block · corps · cuerpo:	PP
Maße · size · mesure · medidas/mm:	415 x 90 x 105
Besatzhöhe · bristle trim · taille garniture · altura cerda/mm:	50
Besatzmaterial · bristle · matériel · material:	PBT Ø 0,25



-20-140°C



HACCP



415 MM



88820U



FC88821U



FC88822U



FC88823U



FC88824U



FC88825U



FC88827U

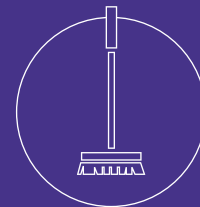

8650

Großraumbesen
great-room-broom
balai pour grands espaces
escobillone para grandes espacios



Körper · block · corps · cuerpo:	PP
Maße · size · mesure · medidas/mm:	625 x 100 x 115
Besatzhöhe · bristle trim · taille garniture · altura cerda/mm:	50
Besatzmaterial · bristle · matériel · material:	PBT Ø 0,25

-20-140°C



HACCP



625 MM



86500



FC86501



FC86502



FC86503



FC86504



FC86505



FC86507

8650U

Großraumbesen
great-room-broom
balai pour grands espaces
escobillone para grandes espacios



Körper · block · corps · cuerpo:	PP
Maße · size · mesure · medidas/mm:	625 x 100 x 115
Besatzhöhe · bristle trim · taille garniture · altura cerda/mm:	50
Besatzmaterial · bristle · matériel · material:	PBT Ø 0,25

-20-140°C



HACCP



625 MM



86500U



FC86501U



FC86502U



FC86503U



FC86504U



FC86505U



FC86507U

8750

Besen
broom
balai
escoba



Körper · block · corps · cuerpo:	PP
Maße · size · mesure · medidas/mm:	340 x 110 x 110
Besatzhöhe · bristle trim · taille garniture · altura cerda/mm:	55
Besatzmaterial · bristle · matériel · material:	HM 30/70

-20-80°C



340/420 MM

8880

Großraumbesen
great-room-broom
balai pour grands espaces
escobillone para grandes espacios



Körper · block · corps · cuerpo:	PP
Maße · size · mesure · medidas/mm:	420 x 100 x 110
Besatzhöhe · bristle trim · taille garniture · altura cerda/mm:	55
Besatzmaterial · bristle · matériel · material:	HM 30/70

-20-80°C



BESEN WEICH • BROOMS SOFT • BALAIS DOUX • ESCOBAS SUAVES

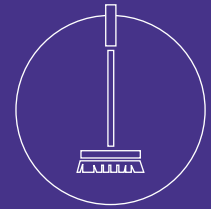

88542

**Tank- & Wandwaschbürste mit
Wasserdurchlauf**
container-and wall-washing-
brush with waterchannel
brosse à laver les réservoirs
et murs à passage d'eau
cepillo con paso de agua para
contenedores y limpieza de
paredes



Körper · block · corps · cuerpo:	PP
Maße · size · mesure · medidas/mm:	290 x 105 x 125
Besatzhöhe · bristle trim · taille garniture · altura cerda/mm:	50
Besatzmaterial · bristle · matériel · material:	PBT Ø 0,25



-20-140°C



HACCP



290 MM

86922

Besen mit Teleskopstiel
Art. 07195
broom with telescopic
handle art. 07195
balai avec manche
télescopique art. 07195
escoba con mango
telescopico art. 07195



Körper · block · corps · cuerpo:	PP
Maße · size · mesure · medidas/mm:	280 x 40 x 210 x 1280/2175
Besatzhöhe · bristle trim · taille garniture · altura cerda/mm:	80
Besatzmaterial · bristle · matériel · material:	PBT Ø 0,25-FE



0-140°C



280/325 MM

8793

Gumminoppenbesen
rubber broom
balai caoutchouc
escoba de goma



Körper · block · corps · cuerpo:	PP
Maße · size · mesure · medidas/mm:	340 x 60 x 120
Besatzhöhe · bristle trim · taille garniture · altura cerda/mm:	35
Besatzmaterial · bristle · matériel · material:	Weichkautschuk soft rubber caoutchouc doux goma suave



0-80°C









340/310 MM





BESEN MITTEL · BROOMS MEDIUM · BALAIS MOYENS · ESCOBAS MEDIOS

310 MM

<h2>8720</h2> <p>Besen broom balai escoba</p>		Körper · block · corps · cuerpo: PP	Maße · size · mesure · medidas/mm: 310 x 95 x 100
		Besatzhöhe · bristle trim · taille garniture · altura cerda/mm: 40	Besatzmaterial · bristle · matériel · material: PBT Ø 0,50
		-20-140°C   HACCP   5	
			

410 MM

<h2>8891</h2> <p>Großraumbesen great-room-broom balai pour grands espaces escobillone para grandes espacios</p>		Körper · block · corps · cuerpo: PP	Maße · size · mesure · medidas/mm: 410 x 85 x 105
		Besatzhöhe · bristle trim · taille garniture · altura cerda/mm: 50	Besatzmaterial · bristle · matériel · material: PBT Ø 0,50
		-20-140°C   HACCP   5	
			

625 MM













<h2>8651</h2> <p>Großraumbesen great-room-broom balai pour grands espaces escobillone para grandes espacios</p>		Körper · block · corps · cuerpo: PP	Maße · size · mesure · medidas/mm: 625 x 100 x 115
		Besatzhöhe · bristle trim · taille garniture · altura cerda/mm: 51	Besatzmaterial · bristle · matériel · material: PBT Ø 0,50
		-20-140°C   HACCP   5	
			

320/430 MM

<h2>8752</h2> <p>Besen broom balai escoba</p>		Körper · block · corps · cuerpo: PP	Maße · size · mesure · medidas/mm: 320 x 75 x 115
		Besatzhöhe · bristle trim · taille garniture · altura cerda/mm: 70	Besatzmaterial · bristle · matériel · material: Arenga
		-20-300°C   10	

<h2>8862</h2> <p>Großraumbesen great-room-broom balai pour grands espaces escobillone para grandes espacios</p>		Körper · block · corps · cuerpo: PP	Maße · size · mesure · medidas/mm: 430 x 110 x 120
		Besatzhöhe · bristle trim · taille garniture · altura cerda/mm: 65	Besatzmaterial · bristle · matériel · material: Arenga
		-20-300°C   10	

BESEN HART · BROOMS HARD · BALAIS DURS · ESCOBAS DUROS

8870		Körper · block · corps · cuerpo:	PP			
		Maße · size · mesure · medidas/mm:	330 x 120 x 135			
Besen broom balai escoba		Besatzhöhe · bristle trim · taille garniture · altura cerda/mm:	65			
		Besatzmaterial · bristle · matériel · material:	PBT Ø 1,0 			
		-20-140°C	  HACCP  			
						
8870	FC88701	FC88702	FC88703	FC88704	FC88705	FC88707

330 MM

8885		Körper · block · corps · cuerpo:	PP			
		Maße · size · mesure · medidas/mm:	410 x 105 x 120			
Großraumbesen great-room-broom balai pour grands espaces escobillone para grandes espacios		Besatzhöhe · bristle trim · taille garniture · altura cerda/mm:	65			
		Besatzmaterial · bristle · matériel · material:	PBT Ø 1,0 			
		-20-140°C	  HACCP  			
						
8885	FC88851	FC88852	FC88853	FC88854	FC88855	FC88857

410 MM

8660		Körper · block · corps · cuerpo:	PP			
		Maße · size · mesure · medidas/mm:	630 x 100 x 135			
Großraumbesen great-room-broom balai pour grands espaces escobillone para grandes espacios		Besatzhöhe · bristle trim · taille garniture · altura cerda/mm:	65			
		Besatzmaterial · bristle · matériel · material:	PBT Ø 1,0 			
		-20-140°C	  HACCP  			
						
8660	FC86601	FC86602	FC86603	FC86604	FC86605	FC86607

630 MM

88722		Körper · block · corps · cuerpo:	PP			
		Maße · size · mesure · medidas/mm:	330 x 120 x 135			
Besen broom balai escoba		Besatzhöhe · bristle trim · taille garniture · altura cerda/mm:	65			
		Besatzmaterial · bristle · matériel · material:	PP Ø 1,0 			
		-20-80°C	 HACCP 			
						
88722	FC88722	FC88723	FC88724	FC88725	FC88726	FC88727

330 MM

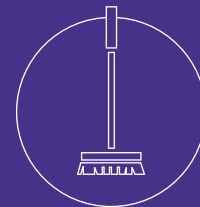

ANWENDUNGSVIDEO
APPLICATION VIDEO
VIDÉO DE DÉMONSTRATION
VÍDEO DE APLICACIÓN



86952

Besen mit Teleskopstiel
 Art. 07195
 broom with telescopic
 handle art. 07195
 balai avec manche
 télescopique art. 07195
 escobs con mango
 telescópico art. 07195



8856

Besen mit Wasserdurchlauf
 broom with waterchannel
 balai à passage d'eau
 escoba con paso de agua



Körper · block · corps · cuerpo:	PP
Maße · size · mesure · medidas/mm:	310 x 90 x 110
Besatzhöhe · bristle trim · taille garniture · altura cerda/mm:	40
Besatzmaterial · bristle · matériel · material:	PBT Ø 0,50 

-20-140°C



HACCP



Körper · block · corps · cuerpo:	PP
Maße · size · mesure · medidas/mm:	325 x 60 x 240 x 1310/2150
Besatzhöhe · bristle trim · taille garniture · altura cerda/mm:	110
Besatzmaterial · bristle · matériel · material:	PBT Ø 0,70-FE 

0-140°C



310/325 MM

88602

Großraumbesen
 great-room-broom
 balai pour grands espaces
 escobillone para grandes
 espacios



Körper · block · corps · cuerpo:	PP
Maße · size · mesure · medidas/mm:	420 x 100 x 120
Besatzhöhe · bristle trim · taille garniture · altura cerda/mm:	65
Besatzmaterial · bristle · matériel · material:	PP Ø 1,0 

-20-80°C



HACCP



8670

Großraumbesen
 great-room-brooms
 balai pour grands espaces
 escobillone para grandes
 espacios



Körper · block · corps · cuerpo:	PP
Maße · size · mesure · medidas/mm:	630 x 95 x 135
Besatzhöhe · bristle trim · taille garniture · altura cerda/mm:	65
Besatzmaterial · bristle · matériel · material:	Arenga 

-20-300°C















420/630 MM

WISCHER + SCHRUBBER · WIPERS + SCRUBS · FROTTOIRS · CEPILLOS PARA FREGAR 200 - 600 MM

<h2>8850</h2> <p>Schrubber scrub frottoir cepillo para fregar</p>		Körper · block · corps · cuerpo: PP	Maße · size · mesure · medidas/mm: 240 x 70 x 100			
		Besatzhöhe · bristle trim · taille garniture · altura cerda/mm: 26	Besatzmaterial · bristle · matériel · material: PBT Ø 0,50			
		-20-140°C   HACCP   10				
 8850	 FC88501	 FC88502	 FC88503	 FC88504	 FC88505	 FC88507

240 MM

<h2>8810</h2> <p>Wischer wiper frottoir cepillo para fregar</p>		Körper · block · corps · cuerpo: PP	Maße · size · mesure · medidas/mm: 285 x 55 x 80			
		Besatzhöhe · bristle trim · taille garniture · altura cerda/mm: 28	Besatzmaterial · bristle · matériel · material: PBT Ø 0,50			
		-20-140°C   HACCP   5				
 8810	 FC88101	 FC88102	 FC88103	 FC88104	 FC88105	 FC88107

285 MM

<h2>88100</h2> <p>Wischer wiper frottoir cepillo para fregar</p>		Körper · block · corps · cuerpo: PP	Maße · size · mesure · medidas/mm: 285 x 55 x 78
		Besatzhöhe · bristle trim · taille garniture · altura cerda/mm: 26	Besatzmaterial · bristle · matériel · material: PP Ø 0,35
		-20-80°C  HACCP  10	

<h2>8770</h2> <p>Wischer wiper frottoir cepillo para fregar</p>		Körper · block · corps · cuerpo: PP	Maße · size · mesure · medidas/mm: 310 x 85 x 95
		Besatzhöhe · bristle trim · taille garniture · altura cerda/mm: 30	Besatzmaterial · bristle · matériel · material: PBT Ø 0,50
		-20-140°C   HACCP   10	

285/310 MM

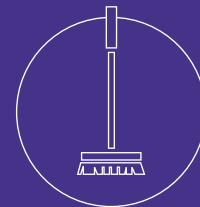

610/620 MM

8630	
Großraumwischer great-room-wiper balai-brosse escobillone para fregar grandes espacios	
Körper · block · corps · cuerpo:	PP
Maße · size · mesure · medidas/mm:	610 x 90 x 95
Besatzhöhe · bristle trim · taille garniture · altura cerda/mm:	35
Besatzmaterial · bristle · matériel · material:	PBT Ø 0,50
-20-140°C	

8640	
Großraumwischer great-room-wiper balai-brosse escobillone para fregar grandes espacios	
Körper · block · corps · cuerpo:	PP
Maße · size · mesure · medidas/mm:	620 x 100 x 105
Besatzhöhe · bristle trim · taille garniture · altura cerda/mm:	45
Besatzmaterial · bristle · matériel · material:	PBT Ø 0,50
-20-140°C	

410 MM

8840	
Großraumwischer great-room-wiper balai-brosse escobillone para fregar grandes espacios	

Körper · block · corps · cuerpo:	PP
Maße · size · mesure · medidas/mm:	410 x 85 x 95
Besatzhöhe · bristle trim · taille garniture · altura cerda/mm:	40
Besatzmaterial · bristle · matériel · material:	PBT Ø 0,50
-20-140°C	

410 MM

8890	
Großraumwischer great-room-wiper balai-brosse escobillone para fregar grandes espacios	

Körper · block · corps · cuerpo:	PP
Maße · size · mesure · medidas/mm:	410 x 70 x 80
Besatzhöhe · bristle trim · taille garniture · altura cerda/mm:	26
Besatzmaterial · bristle · matériel · material:	PBT Ø 0,50
-20-140°C	

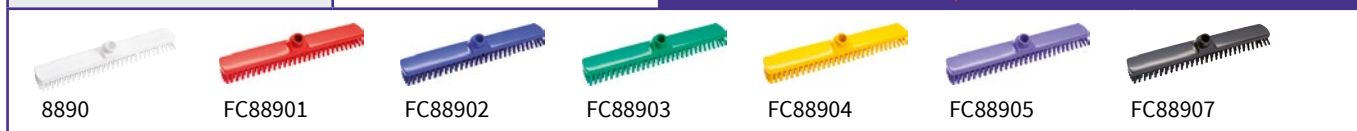

WISCHER + SCHRUBBER · WIPERS + SCRUBS · FROTTOIRS · CEPILLOS PARA FREGAR



ANWENDUNGSVIDEO
APPLICATION VIDEO
VIDÉO DE DÉMONSTRATION
VÉDEO DE APLICACIÓN



8898

Abflussbürste
drain brush
brosse de vidange
cepillo de drenaje

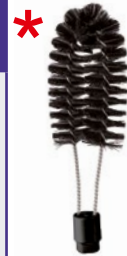

Körper · block · corps · cuerpo: PP
Maße · size · mesure · medidas/mm: 330 x 113 x 55
Besatzhöhe · bristle trim ·
taille garniture ·
altura cerda/mm: 25
Besatzlänge · bristle length ·
longueur matériel · largo
material/mm: 2 x 180
Besatzmaterial · bristle ·
matériel · material: PP Ø 0,50 mm

0-80°C

HACCP



330 MM

8847

Fugenbürste mit Teleskopstiel
Art. 07196

joint-brush with telescopic
handle art. 07196

brosse joint avec manche
télescopique art. 07196

cepillo articulado con mango
telescopico art. 07196



Körper · block · corps · cuerpo: PP
Maße · size · mesure · medidas/mm: 235 x 35 x 1190/2150
Besatzhöhe · bristle trim · taille garniture · altura cerda/mm: 25
Besatzmaterial · bristle · matériel · material: PP Ø 0,60

-20-80°C



235 MM

8842

Eckenschrubber
corner scrub
balai-brosse d'angle
cepillo para fregar esquineros



Körper · block · corps · cuerpo: PP
Maße · size · mesure · medidas/mm: 320 x 135 x 95
Besatzhöhe · bristle trim ·
taille garniture · altura cerda/mm: 45-50
Besatzmaterial · bristle · matériel · material: PBT Ø 0,50

-20-140°C



HACCP



88420



FC88421



FC88422



FC88423



FC88424



FC88425



FC88427

320 MM

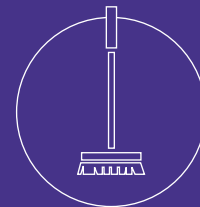

8935

Bodenschaber
floor scraper
raclette à sol
raspadore de piso



8935 89351 89352 89353 89354 89355 89357

Körper · block · corps · cuerpo: PA
Maße · size · mesure · medidas/mm: 250 x 35 x 1382
Arbeitsbreite · width · large · ancho/mm: 250

Material · material · matériel · material:
 Schaber INOX mit Alustiel · scraper INOX with alu handle · racloir INOX avec manche en alu · raspador INOX con mango alu

-20-600°C



HACCP



8936

Bodenschaber
floor scraper
raclette à sol
raspadore de piso



8936 89361 89362 89363 89364 89365 89367

Körper · block · corps · cuerpo: PA
Maße · size · mesure · medidas/mm: 250 x 35 x 1418
Arbeitsbreite · width · large · ancho/mm: 250

Material · material · matériel · material:
 PA-Schaber mit Alustiel · scraper PA with alu handle · racloir en PA avec manche en alu · raspador PA con mango alu

-20-150°C



HACCP



250 MM

88710

Feuchtwischer mit Stahlstiel
sponge mop with metal handle

ensemble lavage de sol
avec manche en métal
mopa-esponja con mango de metal



Maße · size · mesure · medidas/mm: 320 x 85 x 1400

Arbeitsbreite · width · large · ancho/mm: 320

Material · material · matériel · material: Schwamm · sponge · éponge · esponja

0-80°C



320 MM

88719

Ersatzschwamm für Feuchtwischer
refill sponge for sponge mop
recharge éponge pour ensemble lavage de sol
mopa-esponja de repuesto



Maße · size · mesure · medidas/mm: 320 x 85 x 55

Arbeitsbreite · width · large · ancho/mm: 320

Material · material · matériel · material: Schwamm · sponge · éponge · esponja

0-80°C



320 MM

BODEN-WISCHSYSTEME · MOPPING SYSTEMS · SYSTÈMES DE NETTOYAGE DES SOLS · SISTEMAS DE MOPA

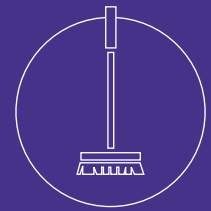

8440

Klapphalter mit 360° Drehgelenk
mop holder with 360° double link
support de lavage avec pivot
de 360°
porta mopa con enlace doble 360°

360°

Körper · block · corps · cuerpo:	PP
Maße · size · mesure · medidas/mm:	395 x 105 x 70
Arbeitsbreite · width · large · ancho/mm:	395
Material · material · matériel · material:	mit Magnetverschluss with magnetic lock avec fermeture magnétique con cierre magnético

0-80°C

8450

Klapphalter mit 360° Drehgelenk
mop holder with 360° double link
support de lavage avec pivot
de 360°
porta mopa con enlace doble 360°

360°

Körper · block · corps · cuerpo:	PP
Maße · size · mesure · medidas/mm:	495 x 120 x 70
Arbeitsbreite · width · large · ancho/mm:	495
Material · material · matériel · material:	mit Magnetverschluss with magnetic lock avec fermeture magnétique con cierre magnético

0-80°C

395/495 MM

8443/8453

Wischbezüge Fransenmopps
fringe mop refills
franges recharges de lavage
mopas-flequillos de repuesto

Maße · size · mesure · medidas/mm:	480 x 210 x 5 / 610 x 250 x 5
Arbeitsbreite · width · large · ancho/mm:	480 / 610
Material · material · matériel · material:	70% CO / 30% PES

0-60°C

8444/8454

Wischbezüge Fransenmopps
fringe mop refills
franges recharges de lavage
mopas-flequillos de repuesto

Maße · size · mesure · medidas/mm:	480 x 210 x 5 / 610 x 250 x 5
Arbeitsbreite · width · large · ancho/mm:	480 / 610
Material · material · matériel · material:	50% CO / 50% PES

0-60°C

480/610 MM

8446/8456

Wischbezüge Microfasermopps
microfiber mop refills
recharges microfibre de lavage
mopas-microfibras de repuesto

Maße · size · mesure · medidas/mm:	450 x 170 x 5 / 550 x 180 x 5
Arbeitsbreite · width · large · ancho/mm:	450 / 550
Material · material · matériel · material:	100% PES

0-95°C

8447/8457

Wischbezüge Microfasermopps
microfiber mop refills
recharges microfibre de lavage
mopas-microfibras de repuesto

Maße · size · mesure · medidas/mm:	450 x 170 x 5 / 550 x 180 x 5
Arbeitsbreite · width · large · ancho/mm:	450 / 550
Material · material · matériel · material:	75% PES / 25% PA

0-60°C

450/550 MM

Anwendungsempfehlung für Wischbezüge Application recommendation for mop covers Recommandation d'application pour couverture de vadrouille Recomendación de aplicación para mopas		Elastische Beläge elastic floor coverings revêtements de sol résilients revestimientos de suelo resilientes			Natur- und Kunststeinbeläge Natural and artificial stone coverings Revêtements en pierre naturelle et artificielle Revestimientos de piedra natural y artificial					Holz- und Laminatflächen wood and laminate bois et stratifié madera y laminado		
Artikelnr. article no. número d'article numero de artículo	Beschreibung description description descripción	PVC	Linoleum linoleum linoleum linóleo	Elastomer elastomer elastomère elastómero	Marmor marble marbre mármol	Granit granite granit granito	Fliesen tiles carrelage losas	Sicherheitsfliesen safety tiles tuiles de sécurité baldozas de seguridad	Porzellansteingewirte grés cérame grés porcelánico	Laminat laminate stratifié laminado	Parquet geölt parquet oiled parquet huilé parquet aceitado	
8443, 8453, 8444, 8454	Wischbezüge Fransenmopps Fringe mop refills Franges rechanges de lavagne mopas-flequillos de repuesto	■	■	■	■	■	■	■	■	■	■	■
8446, 8456	Wischbezüge Microfasermopps Microfiber mop refills Rechanges microfibre de lavagne mopas-microfibras de repuesto	■	■	■	■	■	■	■	■	■	■	■
8447, 8457, 8448, 8458	Wischbezüge Microfasermopps mit Polyamidfasern Microfiber mop refills with polyamid fibres Rechanges microfibre avec polyamide delavage mopas-microfibras con poliamida de repuesto	■	■	■	■	■	■	■	■	■	■	■

450/550 MM

8448/8458



**Wischbezüge Microfasermopps
microfiber mop refills
rechanges microfibre de lavagne
mopas-microfibras de repuesto**

Maße · size · mesure · medidas/mm: 450 x 170 x 5 / 550 x 185 x 5
Arbeitsbreite · width · large · ancho/mm: 450 / 550
Material · material · matériel · material: 78% PES / 22% PA

0-95°C 

optimal, empfohlen zum Nass- und Feuchtwischen
recommended, for wet and damp mopping
recommandé, nettoyage mouillé et humide
recomendado, trapeado mojado y húmedo

nur empfohlen zum nebelfeuchten Wischen
only recommended for damp wiping
recommandé uniquement pour un essuyage humide
solo recomendado para limpieza húmeda

nicht optimal
not optimal
pas optimal
no óptimo

ungeeignet
not suitable
ne convient pas
no adecuado

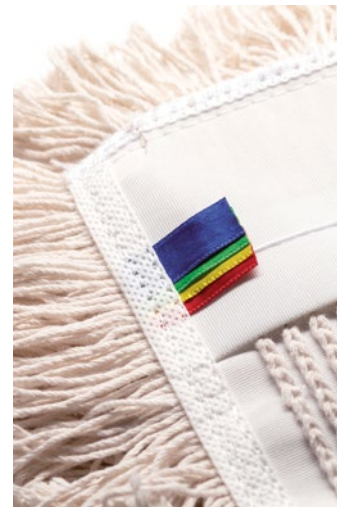

800 MM

8437



**Kentucky Mopp
fringe Kentucky mop
frange de lavagne Kentucky
mopa flequillo Kentucky**

Körper · block · corps · cuerpo: PP
Maße · size · mesure · medidas/mm: 800 x 150 x 10
Material · material · matériel · material: 70% CO / 30% PES



0-60°C 

8430



**Kentucky Mopphalter
Kentucky mop holder
support de lavagne Kentucky
porta mopa Kentucky**

Körper · block · corps · cuerpo: PP
Maße · size · mesure · medidas/mm: 170 x 43 x 130

0-80°C  HACCP 



300 MM

8438



**Mopp
fringe mop
frange de lavagne
mopa flequillo**

Körper · block · corps · cuerpo: PP
Maße · size · mesure · medidas/mm: 300 x 90 x 65
Material · material · matériel · material: 100% CO

0-60°C  

8438_280



**Mopp
fringe mop
frange de lavagne
mopa flequillo**

Körper · block · corps · cuerpo: PP
Maße · size · mesure · medidas/mm: 300 x 105 x 75
Material · material · matériel · material: 100% CO

0-60°C  

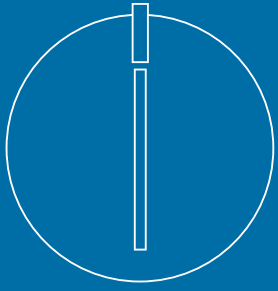

STIELE & ZUBEHÖR
HANDLES & ACCESSORIES
MANCHES & ACCESSOIRES
MANGOS Y ACCESORIOS



8710

Aluminiumstiel
aluminium handle
manche aluminium
mango de aluminio

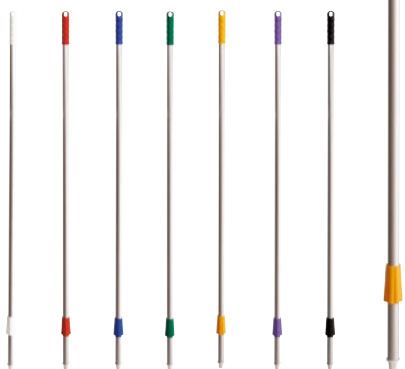

8710 87101 87102 87103 87104 87105 87107

Maße · size · mesure · medidas/mm: 1450 x Ø 42

Außen-Ø · Ø ext./mm: 25

Wandstärke · thickness · paroi · espesor/mm: 1,5

Material · material · matériel · material: ALU

-20-100°C



HACCP



8712

Aluminiumstiel
aluminium handle
manche aluminium
mango de aluminio

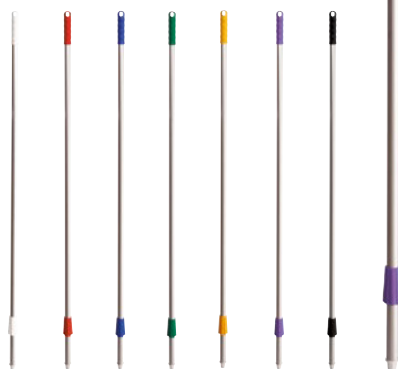

87120 87121 87122 87123 87124 87125 87127

Maße · size · mesure · medidas/mm: 1450 x Ø 42

Außen-Ø · Ø ext./mm: 22

Wandstärke · thickness · paroi · espesor/mm: 1,0

Material · material · matériel · material: ALU

-20-100°C



HACCP



Querschnitt Stielverbindung
original haug Steck-Schraubsystem
cross section of handle connection
connexion de manche transversale
conexión del mango de sección
transversal



8711

Aluminiumstiel
aluminium handle
manche aluminium
mango de aluminio

Maße · size · mesure · medidas/mm: 1000 x Ø 42

Außen-Ø · Ø ext./mm: 25

Wandstärke · thickness · paroi · espesor/mm: 1,5

Material · material · matériel · material: ALU

-20-100°C



HACCP



ALUSTIELE • ALU HANDLES • MANCHES ALUMINIUMS • MANGOS DE ALUMINIO

8714

Aluminiumstiel
aluminium handle
manche aluminium
mango de aluminio



87140 87141 87142 87143 87144

Maße · size · mesure · medidas/mm: 300 x Ø 42
Außen-Ø · Ø ext./mm: 25
Wandstärke · thickness · paroi · espesor/mm: 1,5
Material · material · matériel · material: ALU



8715

Aluminiumstiel
aluminium handle
manche aluminium
mango de aluminio

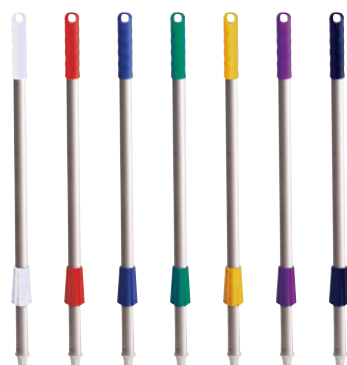

87150 87151 87152 87153 87154 87155 87157

Maße · size · mesure · medidas/mm: 650 x Ø 42
Außen-Ø · Ø ext./mm: 25
Wandstärke · thickness · paroi · espesor/mm: 1,5
Material · material · matériel · material: ALU



8709

Aluminiumstiel
aluminium handle
manche aluminium
mango de aluminio

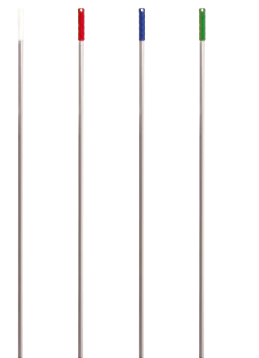

87090 87091 87092 87093 87094

Maße · size · mesure · medidas/mm: 1450 x Ø 27
Außen-Ø · Ø ext./mm: 22
Wandstärke · thickness · paroi · espesor/mm: 1,0
Material · material · matériel · material: ALU



8719

Aluminiumstiel
aluminium handle
manche aluminium
mango de aluminio

Maße · size · mesure · medidas/mm: 1600 x Ø 42
Außen-Ø · Ø ext./mm: 22
Wandstärke · thickness · paroi · espesor/mm: 1,0
Material · material · matériel · material: ALU



87192

Aluminiumstiel
aluminium handle
manche aluminium
mango de aluminio

Maße · size · mesure · medidas/mm: 1600 x Ø 42
Außen-Ø · Ø ext./mm: 22
Wandstärke · thickness · paroi · espesor/mm: 1,0
Material · material · matériel · material: ALU



KUNSTSTOFF- & ALUSTIELE · PLASTIC- & ALU HANDLES · MANCHES PLASTIQUES & ALU · MANGOS DE ERGONÓMICOS & ALUMINIO

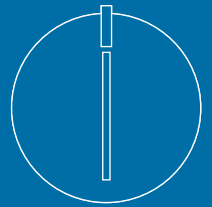

8708

Aluminiumstiel
aluminium handle
manche aluminium
mango de aluminio

8708 87081 87082 87083 87084

Maße · size · mesure · medidas/mm:	1400 x Ø 27
Außen-Ø · Ø ext./mm:	22
Wandstärke · thickness · paroi · espesor/mm:	1,0
Material · material · matériel · material:	ALU

-20-80°C HACCP

871090

Aluminiumstiel
aluminium handle
manche aluminium
mango de aluminio

Alu-Aufhängekappe +
Überwurfmutter
alu hanger + collar
alu poigné + bague
alu manija + collar

Maße · size · mesure · medidas/mm:	1485 x Ø 40
Außen-Ø · Ø ext./mm:	25
Wandstärke · thickness · paroi · espesor/mm:	1,5
Material · material · matériel · material:	ALU

-20-160°C HACCP

8713

Aluminiumstiel mit
Kunststoff-Überzug
plastic coated aluminium handle
manche aluminium avec
couche en plastique
mango de aluminio ergonómicos

8713 87131 87132 87133 87134 87135 87137

Maße · size · mesure · medidas/mm:	1500 x Ø 42
Außen-Ø · Ø ext./mm:	32/25
Wandstärke · thickness · paroi · espesor/mm:	1,5
Material · material · matériel · material:	PP/GF-ALU

-20-80°C HACCP

8697

Kunststoffstiel
plastic handle
manche en plastique
mango ergonómico

Maße · size · mesure · medidas/mm:	1500 x Ø 47
Außen-Ø · Ø ext./mm:	32
Material · material · matériel · material:	PP/GF

-20-80°C HACCP

86970	
86971	
86972	
86973	
86974	
86975	
86977	

8717

Kunststoffgriff
plastic handle
poignée plastique
mango ergonómico



Maße · size · mesure · medidas/mm:	220
Außen-Ø · Ø ext./mm:	25
Material · material · matériel · material:	PP

-20-160°C HACCP

FIBERGLASSTIELE • FIBERGLASS HANDLES • MANCHES EN FIBRE DE VERRE • MANGOS DE FIBRA DE VIDRIO



8705

Fiberglasstiel
fiberglass handle
manche en fibre de verre
mango de fibra de vidrio



8705 87051 87052 87053 87054 87055 87057

Maße · size · mesure · medidas/mm:	1450 x Ø 42
Außen-Ø · Ø ext./mm:	25
Wandstärke · thickness · paroi · espesor/mm:	1,5
Material · material · matériel · material:	Fiberglas · fiberglass · fibre de verre · fibra de vidrio

-20-100°C   



8706

Fiberglasstiel
fiberglass handle
manche en fibre de verre
mango de fibra de vidrio

87060 87061 87062 87063 87064

Maße · size · mesure · medidas/mm:	1300 x Ø 42
Außen-Ø · Ø ext./mm:	25
Wandstärke · thickness · paroi · espesor/mm:	1,5
Material · material · matériel · material:	Fiberglas · fiberglass · fibre de verre · fibra de vidrio



-20-100°C   

8707

Fiberglasstiel
fiberglass handle
manche en fibre de verre
mango de fibra de vidrio



Maße · size · mesure · medidas/mm:	1000 x Ø 42
Außen-Ø · Ø ext./mm:	25
Wandstärke · thickness · paroi · espesor/mm:	1,5
Material · material · matériel · material:	Fiberglas · fiberglass · fibre de verre · fibra de vidrio

-20-100°C   



**Fiberglasstiele: nicht kälteleitend · fiberglass handles: non-cold-conductive ·
manches en fibre de verre: ne transmettant pas le froid · mangos de fibra de vidrio: aislante térmico**





8704_01



Fiberglasstiel mit Schlauchanschluss
fiberglass handle with connecting hose
manche en fibre de verre avec robinet pour passages d'eau
mango de fibra de vidrio con conexión para manguera

Maße · size · mesure · medidas/mm:	1450 x Ø 42
Außen-Ø · Ø ext./mm:	25
Wandstärke · thickness · paroi · espesor/mm:	1,5
Material · material · matériel · material:	Fiberglas · fiberglass · fibre de verre · fibra de vidrio

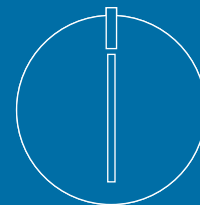



-20-75°C   

STAHL- & TELESKOPSTIELE • METAL- & TELESCOPIC HANDLES • MANCHES EN MÉTAL & TÉLESCOPIQUE • MANGOS DE METAL & TELESÓPICOS









87100	Maße · size · mesure · medidas/mm:	1400 x Ø 42
	Außen-Ø · Ø ext./mm:	21
	Wandstärke · thickness · paroi · espesor/mm:	0,40
	Material · material · matériel · material:	FE
Stahlstiel metal handle manche métallique mango de metal		
		0-80°C  





87022	Maße · size · mesure · medidas/mm:	1040/1750 x Ø 42
	Außen-Ø · Ø ext./mm:	22/25
	Wandstärke · thickness · paroi · espesor/mm:	1,0
	Material · material · matériel · material:	ALU
Alu-Teleskopstiel telescopic alu handle manche télescopique en alu mango telescópico de alu		
		-20-100°C   HACCP  







87025	Maße · size · mesure · medidas/mm:	1485/2500 x Ø 42
	Außen-Ø · Ø ext./mm:	22/25
	Wandstärke · thickness · paroi · espesor/mm:	1,0
	Material · material · matériel · material:	ALU
Alu-Teleskopstiel telescopic alu handle manche télescopique en alu mango telescópico de alu		
		-20-100°C   HACCP  



8689	Maße · size · mesure · medidas/mm:	1710/4500
	Außen-Ø · Ø ext./mm:	21/25/30
	Wandstärke · thickness · paroi · espesor/mm:	1,0/1,4/1,5
	Material · material · matériel · material:	ALU
Alu-Teleskopstiel 3-tlg. telescopic alu handle 3pcs. manche télescopique en alu 3pcs. mango telescópico de alu 3pzas.		
		für Art. 8500, 8550 · for art. 8500, 8550 · pour art. 8500, 8550 · para art. 8500, 8550
		-20-100°C HACCP  



86981	Maße · size · mesure · medidas/mm:	1020/1800 x Ø 61
	Außen-Ø · Ø ext./mm:	22/32
	Wandstärke · thickness · paroi · espesor/mm:	1,2
	Material · material · matériel · material:	PP/GF - ALU
Alu-Teleskopstiel telescopic alu handle manche télescopique en alu mango telescópico de alu		
		-20-80°C   HACCP  

STAHL- & TELESKOPSTIELE • METAL & TELESCOPIC HANDLES • MANCHES EN MÉTAL & TÉLESCOPIQUE • MANGOS DE METAL & TELESÓPICOS

8703

Alu-Teleskopstiel
telescopic alu handle
manche télescopique en alu
mango telescópico de alu



8703 87031 87032 87033 87034 87035 87037

Maße · size · mesure · medidas/mm:	2180/4000 x Ø 42
Außen-Ø · Ø ext./mm:	22/25
Wandstärke · thickness · paroi · espesor/mm:	1,0
Material · material · matériel · material:	ALU

-20-100°C



HACCP



8701

Teleskopstiel Stahlrohr
telescopic metal handle
manche télescopique en métal
mango telescópico de metal

Maße · size · mesure · medidas/mm:	1090/2000 x Ø 42
Außen-Ø · Ø ext./mm:	21/25
Wandstärke · thickness · paroi · espesor/mm:	0,40
Material · material · matériel · material:	FE

0-80°C



07195

Teleskopstiel Stahlrohr
telescopic metal handle
manche télescopique en métal
mango telescópico de metal

Maße · size · mesure · medidas/mm:	1090/2000
Außen-Ø · Ø ext./mm:	21/25
Wandstärke · thickness · paroi · espesor/mm:	0,40
Material · material · matériel · material:	FE

0-80°C



07196

Teleskopstiel Stahlrohr
telescopic metal handle
manche télescopique en métal
mango telescópico de metal

Maße · size · mesure · medidas/mm:	1090/2000
Außen-Ø · Ø ext./mm:	21/25
Wandstärke · thickness · paroi · espesor/mm:	0,40
Material · material · matériel · material:	FE

0-80°C



07198

Teleskopstiel Stahlrohr
telescopic metal handle
manche télescopique en métal
mango telescópico de metal





Maße · size · mesure · medidas/mm:	1160/2000
Außen-Ø · Ø ext./mm:	15/20
Wandstärke · thickness · paroi · espesor/mm:	0,40
Material · material · matériel · material:	FE

0-80°C

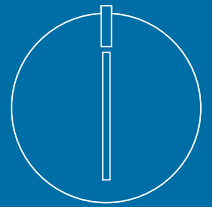













STIELE-ZUBEHÖR • HANDLES ACCESSORIES • MANCHES ACCESSOIRES • VIDRIO ACCESORIOS



E1100007	
Konus cone cône cono	 -000
Körper · block · corps · cuerpo:	PA GF
Maße · size · mesure · medidas/mm:	60 x Ø 29
Anwendung · use · usage · uso:	für Stiele mit Außen-Ø 25 mm · for handles with Ø 25 mm · pour manches en Ø 25 mm · para mangos de Ø 25 mm
-20-160°C   HACCP  	

E1100009	
Konus cone cône cono	  -000 -080
Körper · block · corps · cuerpo:	PP GF
Maße · size · mesure · medidas/mm:	60 x Ø 29
Anwendung · use · usage · uso:	für Stiele mit Außen-Ø 21+22 mm · for handles with Ø 21+22 mm · pour manches en Ø 21+22 mm · para mangos de Ø 21+22 mm
-20-80°C   HACCP  	

E1100017	
Konus cone cône cono	 -000
Körper · block · corps · cuerpo:	PP
Maße · size · mesure · medidas/mm:	37 x Ø 32
Anwendung · use · usage · uso:	für Rohrbürsten* · for tube-brushes* · pour écouvillons* · para hisopos limpia-tubos* *8908/8909/8910/8911
0-80°C    HACCP  	

E1100019	
Konus cone cône cono	 -000
Körper · block · corps · cuerpo:	PA GF
Maße · size · mesure · medidas/mm:	50 x Ø 28
Anwendung · use · usage · uso:	für Überwurfmutter E1100018 · for collar E1100018 · pour bague E1100018 · para collar E1100018
-20-160°C    HACCP  	

STIELE-ZUBEHÖR • HANDLES ACCESSORIES • MANCHES ACCESSOIRES • VIDRIO ACCESORIOS

E1100008

Überwurfmutter
collar
bague
collare



-000



-084 -044 -074
-014 -005 -080

Körper · block · corps · cuerpo: PA
Maße · size · mesure · medidas/mm: 74 x Ø 42
Anwendung · use · usage · uso:
für Stiele mit Außen-Ø 25 mm · for handles with Ø 25 mm · pour manches en Ø 25 mm · para mangos de Ø 25 mm

-20-100°C   HACCP  

E1100010

Überwurfmutter
collar
bague
collare



-000



-084 -044 -074
-014 -005 -080

Körper · block · corps · cuerpo: PA
Maße · size · mesure · medidas/mm: 74 x Ø 42
Anwendung · use · usage · uso:
für Stiele mit Außen-Ø 21+22 mm · for handles with Ø 21+22 mm · pour manches en Ø 21+22 mm · para mangos de Ø 21+22 mm

-20-100°C   HACCP  

E1100018

Überwurfmutter
collar
bague
collare



-000



-084 -044 -074 -014

Körper · block · corps · cuerpo: PA
Maße · size · mesure · medidas/mm: 74 x Ø 38
Anwendung · use · usage · uso:
für Adapter E1100019 · for adapter E1100019 · pour adaptateur E1100019 · para adaptador E1100019

-20-100°C   HACCP  

E1100004

Aufhängekappe
hanger
poignée
manija







-000



-084 -044 -074
-014 -005 -080

Körper · block · corps · cuerpo: PP
Maße · size · mesure · medidas/mm: 125 x Ø 30
Anwendung · use · usage · uso:
für Stiele mit Außen-Ø 25 mm · for handles with Ø 25 mm · pour manches en Ø 25 mm · para mangos de Ø 25 mm

-20-80°C   HACCP  

E1100012

Aufhängekappe
hanger
poignée
manija







-000





-084 -044 -074
-014 -005 -080

Körper · block · corps · cuerpo: PP
Maße · size · mesure · medidas/mm: 125 x Ø 24
Anwendung · use · usage · uso:
für Stiele mit Außen-Ø 22 mm · for handles with Ø 22 mm · pour manches en Ø 22 mm · para mangos de Ø 22 mm

-20-80°C   HACCP  





E1100013

Aufhängekappe
hanger
poignée
manija

-044 -080

Körper · block · corps · cuerpo: PP
Maße · size · mesure · medidas/mm: 125 x Ø 21
Anwendung · use · usage · uso:
für Stiele mit Außen-Ø 21 mm · for handles with Ø 21 mm · pour manches en Ø 21 mm · para mangos de Ø 21 mm

-20-80°C   HACCP  

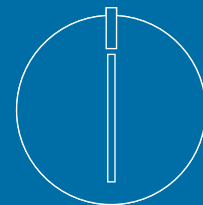

069

**Besenkamm
broom comb
peigne pour balai
peine para escobas**



Körper · block ·
corps · cuerpo: PP

Maße · size · mesure ·
medidas/mm: 112 x 45 x 15

Anwendung · use · usage · uso:
Kann an Stielen mit Außen-Ø 25 mm be-
festigt werden, geeignet zum Auskämmen
von Besen · fits on all handles til Ø 25 mm,
suitable for combing brooms · peut être fixé
aux manches avec un diamètre jusqu'à
Ø 25 mm, adapté pour peigner des balais ·
se puede fijar a mangos con diámetro a
25 mm, adecuado para peinar escobas



E1100022

**Adapter
adapter
adapteur
adaptador**



-000

Körper · block ·
corps · cuerpo: PP

Maße · size · mesure ·
medidas/mm: 34,5 x Ø 40

Anwendung · use · usage · uso:
für 6-Kant Stiel auf 8-Kant Artikel · for 6 edges
handle on 8 edges articles · pour hexagone
manche sur octogonals articles · para hexá-
gone mangos en octogonals articulos



E1100023

**Adapter
adapter
adapteur
adaptador**



-044

Körper · block ·
corps · cuerpo: PP

Maße · size · mesure ·
medidas/mm: 34,5 x Ø 40

Anwendung · use · usage · uso:
für 8-Kant Stiel auf 6-Kant Artikel · for 8 edges
handle on 6 edges articles · pour octogonal
manche sur hexagones articles · para octo-
gonals mangos en hexágone articulos



8716

**Winkeladapter
swivel-adapter
adaptateur d'angle
adaptador con rosca
giratoria**



Körper · block ·
corps · cuerpo: PA GF

Maße · size · mesure ·
medidas/mm: 110 x Ø 37

Anwendung · use · usage · uso:
variable Stielstellung mit 180° Drehgelenk ·
flexible handle position with 180° double
link · position de manche flexible avec pivot
de 180° · posición de mango flexible con
enlace doble 180°





WAND- & DECKENGERÄTE
WALL & CEILING ARTICLES
ÉQUIPEMENT AU MUR & AU PLAFOND
ARTICULOS DE PARED Y TECHO



GERÄTELEISTEN • EQUIPMENT BORDERS • BARRES D'OUTILS • RIELES-ORGANIZADORES PARA EQUIPOS

8680

Alu-Geräteleiste PRO
alu equipment border PRO
barre d'outils en alu PRO
rieles-organizadores de aluminio
para equipos PRO



Körper • block • corps • cuerpo: ALU/PP/TPE
Maße • size • mesure • medidas/mm: 540 x 55 x 30

Anwendung • use • usage • uso:
ohne Stielhalterungen, mit Befestigungsmaterial • without handle fixations,
with fixing material • sans fixations, avec matériel fixation • sin fijaciones
para mango, con material de fijación

-20-121°C



HACCP



86800



86801



86802



86803



86804



86805



86807

8681

Alu-Geräteleiste PRO
alu equipment border PRO
barre d'outils en alu PRO
rieles-organizadores de aluminio
para equipos PRO



Körper • block • corps • cuerpo: ALU/PP/TPE
Maße • size • mesure • medidas/mm: 940 x 55 x 30

Anwendung • use • usage • uso:
ohne Stielhalterungen, mit Befestigungsmaterial • without handle fixations,
with fixing material • sans fixations, avec matériel fixation • sin fijaciones
para mango, con material de fijación

-20-121°C



HACCP



86810



86811



86812



86813



86814



86815



86817

8682

Stielhalterung PRO
handle fixation PRO
recharge pour barre PRO
barre fijacion de repuesto PRO



Körper • block • corps • cuerpo: POM/PP/TPE
Maße • size • mesure • medidas/mm: 70 x 35 x 75

Anwendung • use • usage • uso:
für Art. 86800-7 und Art. 86810-7, für Griffe bis Außen-Ø 25 mm • for art.
86800-7 and art. 86810-7, for handles til Ø 25 mm • pour art. 86800-7 et
art. 86810-7, pour manches jusqu'à Ø 25 mm de diamètre • para art. 86800-7
y art. 86810-7, para mangos hasta 25 mm di diámetro

-20-121°C



HACCP



86820



86821



86822



86823



86824



86825



86827

8683

Stielhalterung Haken PRO
handle fixation PRO
recharge pour barre PRO
barre fijacion de repuesto PRO



Körper • block • corps • cuerpo: POM
Maße • size • mesure • medidas/mm: 63 x 50 x 35

Anwendung • use • usage • uso:
für Art. 86800-7 und Art. 86810-7 • for art. 86800-7 and art. 86810 •
pour art. 86800-7 et art. 86810-7 • para art. 86800-7 y art. 86810-7

-20-121°C



HACCP



86830



86831



86832



86833



86834













86835



86837











GERÄTELEISTEN • EQUIPMENT BORDERS • BARRES D'OUTILS • RIELES-ORGANIZADORES PARA EQUIPOS

8684		Körper · block · corps · cuerpo:	POM
		Maße · size · mesure · medidas/mm:	70 x 36 x 13
Adapter PRO adapter PRO adapteur PRO adaptador PRO		Anwendung · use · usage · uso: für Art. 86820-7 und Art. 86830-7 für Wandmontage · for art. 86820-7 and art. 86830-7 for wall mounting · pour art. 86820-7 et art. 86830-7 pour montage mural · para art. 86820-7 y art. 86830-7 para montaje en pared	
		-20-80°C	

8699		Körper · block · corps · cuerpo:	ALU/ABS/TPE			
		Maße · size · mesure · medidas/mm:	517 x 55 x 85			
Alu-Geräteleiste alu equipment border barres d'outils en alu rieles-organizadores de aluminio para equipos		Anwendung · use · usage · uso: mit 3 Stielhalterungen (Art. 86999) · with 3 handle fixations (art. 86999) avec 3 fixations (art. 86999) · con 3 fijaciones para mango (art. 86999)				
		-20-180°C	HACCP  			
						
8699	8699_1	8699_2	8699_3	8699_4	8699_5	8699_7

86996		Körper · block · corps · cuerpo:	ABS/TPE
		Maße · size · mesure · medidas/mm:	80 x 35 x 75
Ersatz-Stielhalterung refill handle fixation recharge pour barre fijacion de repuesto		Anwendung · use · usage · uso: für Art. 8699, für Griffe mit Ø 30-40 mm · for art. 8699, for handles in Ø 30-40 mm · pour art. 8699, pour manches en Ø 30-40 mm · para art. 8699, para mangos de Ø 30-40 mm	
		-5-60°C	HACCP  

86998		Körper · block · corps · cuerpo:	ABS/TPE
		Maße · size · mesure · medidas/mm:	60 x 35 x 73
Ersatz-Stielhalterung refill handle fixation recharge pour barre fijacion de repuesto		Anwendung · use · usage · uso: für Art. 8699, für Griffe mit Ø 15-20 mm · for art. 8699, for handles in Ø 15-20 mm · pour art. 8699, pour manches en Ø 15-20 mm · para art. 8699, para mangos de Ø 15-20 mm	
		-5-60°C	HACCP  

86997		Körper · block · corps · cuerpo:	ABS			
		Maße · size · mesure · medidas/mm:	42 x 32 x 31			
Stielhalterung Haken handle fixation recharge pour barre barre fijacion de repuesto		Anwendung · use · usage · uso: für Art. 8699 · for art. 8699 · pour art. 8699 · para art. 8699				
		HACCP  				
						
86997	86997_1	86997_2	86997_3	86997_4	86997_5	86997_7



<h2>86999</h2> <p>Stielhalterung handle fixation recharge pour barre barre fijacion de repuesto</p>		<p>Körper · block · corps · cuerpo: ABS/TPE</p>	<p>Maße · size · mesure · medidas/mm: 70 x 35 x 75</p>
		<p>Anwendung · use · usage · uso: für Art. 8699, für Griffe mit Ø 20-30 mm • for art. 8699, for handles in Ø 20-30 mm • pour art. 8699, pour manches en Ø 20-30 mm • para art. 8699, para mangos de Ø 20-30 mm</p>	
		-5-60°C	HACCP
<p>86999 86999_1 86999_2 86999_3 86999_4 86999_5 86999_7</p>			

<h2>8688</h2> <p>Kunststoff-Geräteleiste plastic equipment border barre d'outils en plastique riele-organizadores plástico para equipos</p>		<p>Körper · block · corps · cuerpo: PP/TPE</p>	<p>Maße · size · mesure · medidas/mm: 200 x 70 x 125</p>
		<p>Anwendung · use · usage · uso: für 4 Arbeitsgeräte mit Griffen von Ø 21-38 mm • for 4 cleaning tools with handles in Ø 21-38 mm • pour 4 outils avec manches en Ø 21-38 mm • para 4 artículos de limpieza con mangos de Ø 21-38 mm</p>	
		-20-80°C	HACCP
<p>86880 86881 86882 86883 86884</p>			

<h2>8700</h2> <p>Kunststoff-Geräteleiste plastic equipment border barre d'outils en plastique riele-organizadores plástico para equipos</p>		<p>Körper · block · corps · cuerpo: PP</p>	<p>Maße · size · mesure · medidas/mm: 440 x 50 x 20</p>
		<p>Anwendung · use · usage · uso: mit 5 Haken · with 5 hooks • avec 5 crochets • con 5 ganchos</p>	
		-20-80°C	

PADS, PADHALTER + STAUB-& SPEZIALBÜRSTEN · PADS, PAD HOLDERS + SPECIAL BRUSHES · PADS, PORTE PADS + BROSSES SPÉCIALES · PADS, PORTAS PADS + CEPILLOS ESPECIALES

<h2>8899</h2> <p>Außenrohrbürste outer-tube-brush brosse pour nettoyer de l'extérieur des tuyaux hisopo limpia tuberías y exteriores</p> <p>Bürste formbar für diverse Rohrdurchmesser · brush changeable for different tube diameters • brosse modifiable pour différents diamètres des tuyaux • cepillo adaptable para diámetros de tuberías diferentes</p>		<p>Körper · block · corps · cuerpo: PP</p>	<p>Maße · size · mesure · medidas/mm: 190 x 170 x 13</p>
		<p>Besatzhöhe · bristle trim · taille garniture · altura cerda/mm: 65</p>	
		<p>Besatzlänge · bristle length · longueur matériel · largo material/mm: 190</p>	
		<p>Besatzmaterial · bristle · matériel · material: PBT Ø 0,25</p>	
		-20-140°C	HACCP

PADS, PADHALTER + STAUB- & SPEZIALBÜRSTEN • PADS, PAD HOLDERS + SPECIAL BRUSHES • PADS, PORTE PADS + BROSSES SPÉCIALES • PADS, PORTAS PADS + CEPILLOS ESPECIALES

<p>8895</p> <p>Staubmagnet duster époussette cepillo plumeros</p>		<table border="1"> <tr> <td>Körper · block · corps · cuerpo:</td> <td>PP</td> </tr> <tr> <td>Maße · size · mesure · medidas/mm:</td> <td>170 x Ø 210</td> </tr> <tr> <td>Besatzhöhe · bristle trim · taille garniture · altura cerda/mm:</td> <td>75</td> </tr> <tr> <td>Besatzmaterial · bristle · matériel · material:</td> <td>PBT Ø 0,25 </td> </tr> </table> <p>-20-140°C   HACCP  </p>	Körper · block · corps · cuerpo:	PP	Maße · size · mesure · medidas/mm:	170 x Ø 210	Besatzhöhe · bristle trim · taille garniture · altura cerda/mm:	75	Besatzmaterial · bristle · matériel · material:	PBT Ø 0,25 
Körper · block · corps · cuerpo:	PP									
Maße · size · mesure · medidas/mm:	170 x Ø 210									
Besatzhöhe · bristle trim · taille garniture · altura cerda/mm:	75									
Besatzmaterial · bristle · matériel · material:	PBT Ø 0,25 									
<p>88542</p> <p>Tank- & Wandwaschbürste mit Wasserdurchlauf container-and wall-washing- brush with waterchannel brosse à laver les reservoirs et murs à passage d'eau cepillo con paso de agua para contenedores y limpieza de paredes</p>		<table border="1"> <tr> <td>Körper · block · corps · cuerpo:</td> <td>PP</td> </tr> <tr> <td>Maße · size · mesure · medidas/mm:</td> <td>290 x 105 x 125</td> </tr> <tr> <td>Besatzhöhe · bristle trim · taille garniture · altura cerda/mm:</td> <td>50</td> </tr> <tr> <td>Besatzmaterial · bristle · matériel · material:</td> <td>PBT Ø 0,25 </td> </tr> </table> <p>-20-140°C   HACCP  </p>	Körper · block · corps · cuerpo:	PP	Maße · size · mesure · medidas/mm:	290 x 105 x 125	Besatzhöhe · bristle trim · taille garniture · altura cerda/mm:	50	Besatzmaterial · bristle · matériel · material:	PBT Ø 0,25 
Körper · block · corps · cuerpo:	PP									
Maße · size · mesure · medidas/mm:	290 x 105 x 125									
Besatzhöhe · bristle trim · taille garniture · altura cerda/mm:	50									
Besatzmaterial · bristle · matériel · material:	PBT Ø 0,25 									
<p>8478</p> <p>Staubmagnet duster époussette cepillo-plumeros</p>		<table border="1"> <tr> <td>Körper · block · corps · cuerpo:</td> <td>PP</td> </tr> <tr> <td>Maße · size · mesure · medidas/mm:</td> <td>605 x 100 x 27</td> </tr> <tr> <td>Besatzmaterial · material · matériel · material:</td> <td>Chenille</td> </tr> <tr> <td>biegbar · bendable · pirable · flexible</td> <td></td> </tr> </table> <p>0-60°C  </p>	Körper · block · corps · cuerpo:	PP	Maße · size · mesure · medidas/mm:	605 x 100 x 27	Besatzmaterial · material · matériel · material:	Chenille	biegbar · bendable · pirable · flexible	
Körper · block · corps · cuerpo:	PP									
Maße · size · mesure · medidas/mm:	605 x 100 x 27									
Besatzmaterial · material · matériel · material:	Chenille									
biegbar · bendable · pirable · flexible										
<p>8617</p> <p>Boden-Padhalter floor pad holder raclette multi-fonctions au sol porta pad para mango</p>		<table border="1"> <tr> <td>Körper · block · corps · cuerpo:</td> <td>PP</td> </tr> <tr> <td>Maße · size · mesure · medidas/mm:</td> <td>230 x 95 x 55</td> </tr> <tr> <td>ohne Pads · without pads · sans pads · sin pads</td> <td></td> </tr> </table> <p>0-80°C   HACCP  </p>	Körper · block · corps · cuerpo:	PP	Maße · size · mesure · medidas/mm:	230 x 95 x 55	ohne Pads · without pads · sans pads · sin pads			
Körper · block · corps · cuerpo:	PP									
Maße · size · mesure · medidas/mm:	230 x 95 x 55									
ohne Pads · without pads · sans pads · sin pads										
<p>8618</p> <p>Scheuerpad für Art. 8617 fleece pad for art. 8617 pad pour art. 8617 pad de fibra para art. 8617</p>		<table border="1"> <tr> <td>Maße · size · mesure · medidas/mm:</td> <td>270 x 130 x 5</td> </tr> <tr> <td>Material · material · matériel · material:</td> <td></td> </tr> <tr> <td>75% PES/25% PA · abrasiv · abrasive · abrasif · abrasivo</td> <td></td> </tr> </table> <p>0-80°C  </p>	Maße · size · mesure · medidas/mm:	270 x 130 x 5	Material · material · matériel · material:		75% PES/25% PA · abrasiv · abrasive · abrasif · abrasivo			
Maße · size · mesure · medidas/mm:	270 x 130 x 5									
Material · material · matériel · material:										
75% PES/25% PA · abrasiv · abrasive · abrasif · abrasivo										

8623

Scheuerpads für Art. 86162+8617
fleece pads for art. 86162+8617
pads pour art. 86162+8617
pads de fibra para art. 86162+8617



Maße · size · mesure · medidas/mm:

260 x 120 x 25

Material · material · matériel · material:
synthetisches Faservlies · synthetic fleece ·
tampon synthétique · fibra sintética
3 St. · 3 pcs. · 3 pcs. · 3 pzas.



0-100°C



8624

Scheuerpads für Art. 86162+8617
fleece pads for art. 86162+8617
pads pour art. 86162+8617
pads de fibra para art. 86162+8617



Maße · size · mesure · medidas/mm:

260 x 120 x 25

Material · material · matériel · material:
synthetisches Faservlies · synthetic fleece ·
tampon synthétique · fibra sintética
3 St. · 3 pcs. · 3 pcs. · 3 pzas.



0-100°C



8625

Scheuerpads für Art. 86162+8617
fleece pads for art. 86162+8617
pads pour art. 86162+8617
pads de fibra para art. 86162+8617



Maße · size · mesure · medidas/mm:

260 x 120 x 25

Material · material · matériel · material:
synthetisches Faservlies · synthetic fleece ·
tampon synthétique · fibra sintética
3 St. · 3 pcs. · 3 pcs. · 3 pzas.



0-100°C



8615

Scheuerpads für Art. 8610
fleece pads for art. 8610
pads pour art. 8610
pads de fibra para art. 8610



Maße · size · mesure · medidas/mm:

150 x 100 x 25

Material · material · matériel · material:
synthetisches Faservlies · synthetic fleece ·
tampon synthétique · fibra sintética
3 St. · 3 pcs. · 3 pcs. · 3 pzas.



0-100°C



8610

Langstiel-Grillreiniger
grill-cleaner with long handle
nettoyant pour barbecue avec manche long
limpiador de barbacoa con mango largo



Körper · block · corps · cuerpo:

PA GF

Maße · size · mesure · medidas/mm:

460 x 150 x 110

mit 2 Pads · with 2 pads ·
avec 2 pads · con 2 pads

0-100°C



86162

Hand-Padhalter
hand pad holder
raclette multi-fonctions à main
porta pad a mano



Körper · block · corps · cuerpo:

PP

Maße · size · mesure ·
medidas/mm:

237 x 91 x 66

Anwendung · use · usage · uso:

ohne Pads · without pads · sans pads · sin pads

0-80°C

HACCP





**SCHAUFELN & FAHREIMER & EIMER
SHOVELS & TROLLEYS & BUCKETS
PÈLES & CHARIOTS & SEAUX
PALAS & CARROS & BALDES**





8920

Schaufel einteilig groß
shovel one piece big
pèle une pièce grande
pala una pieza grande



Körper · block · corps · cuerpo: PP
Maße · size · mesure · medidas/mm: 1135 x 345 x 180
Anwendung · use · usage · uso:
maximale Traglast ~30 kg · maximum carrying load ~30 kg ·
charge maximale ~30 kg · carga máxima ~30 kg

-20-80°C



HACCP



8920



89201



89202



89203



89204



89205

8921

Schaufel einteilig klein
shovel one piece small
pèle une pièce petite
pala una pieza pequeña



Körper · block · corps · cuerpo: PP
Maße · size · mesure · medidas/mm: 1115 x 345 x 180
Anwendung · use · usage · uso:
maximale Traglast ~30 kg · maximum carrying load ~30 kg ·
charge maximale ~30 kg · carga máxima ~30 kg

-20-80°C



HACCP



8921



89211



89212



89213



89214

8938

Holsteiner Schaufel
mit Stiel #8713
shovel Holstein
with handle #8713
pèle Holstein avec manche #8713
pala Holstein con mango #8713



Körper · block · corps · cuerpo: FE/ALU/PP
Maße · size · mesure · medidas/mm: 1470 x 255 x 165
Material · material · matériel · material:
• Schaufel: FE gehärtet und unlackiert · shovel: FE hardened and unpainted
• pèle: FE durci et non peint · pala: FE endurecido y sin pintar

-20-80°C



HACCP



89380



89381



89382



89383



89384



89385



89387

SCHAUFELN • SHOVELS • PÈLES • PALAS

89400

Schaufel einteilig groß
shovel one piece big
pèle une pièce grande
pala una pieza grande



Körper · block · corps · cuerpo: PP
Maße · size · mesure · medidas/mm: 1175 x 310 x 120

-20-80°C HACCP

89410

Schaufel einteilig klein
shovel one piece small
pèle une pièce petite
pala una pieza pequeña



Körper · block · corps · cuerpo: PP
Maße · size · mesure · medidas/mm: 1150 x 260 x 120

-20-80°C HACCP

8919

Mehrzweck- und
Abschöpfgabel
utility fork
fourche alimentaire
horqueta



Körper · block · corps · cuerpo: PP
Maße · size · mesure · medidas/mm: 952 x 322 x 160

-20-80°C HACCP





8960

Eimer
bucket
seau
balde



Körper · block · corps · cuerpo: PP
Maße · size · mesure · medidas/mm: 510 x 285 x 255
Anwendung · use · usage · uso:
Fassungsvermögen ~20l · capacity ~20l · capacité ~20l · capacidad ~20l

-20-80°C HACCP

 8960
 89601
 89602
 89603
 89204

89641

Eimer
bucket
seau
balde



Körper · block · corps · cuerpo: PP
Maße · size · mesure · medidas/mm: 340 x 335 x 285
Anwendung · use · usage · uso:
Fassungsvermögen ~15l · capacity ~15l · capacité ~15l · capacidad ~15l

0-80°C HACCP

89642

Eimer
bucket
seau
balde



Körper · block · corps · cuerpo: PP
Maße · size · mesure · medidas/mm: 340 x 335 x 285
Anwendung · use · usage · uso:
Fassungsvermögen ~15l · capacity ~15l · capacité ~15l · capacidad ~15l

0-80°C HACCP

8969

Warnschild
„Rutschgefahr“
warning sign „wet floor“
panneau d'avertissement „sol mouillé“
señal de advertencia „suelo mojado“



Körper · block · corps · cuerpo: PP
Maße · size · mesure · medidas/mm: 600 x 290 x 30

0-80°C HACCP



8961

Fahreimer mit Mopp-Pressse
plastic mop trolley with wringer
chariot de ménage avec presse
carro plástico con prensa



Körper · block · corps · cuerpo: PP/ALU

Maße · size · mesure · medidas/mm: 520 x 420 x 530/740

Anwendung · use · usage · uso:

1 Eimer mit 15 l, mit Mopp-Pressse · 1 bucket with 15 l, with plastic wringer · 1 seau avec 15 l, avec presse verticale à mâchoires · 1 balde de 15 l, con prensa para mopas



8962

Fahreimer mit Mopp-Pressse
plastic mop trolley with wringer
chariot de ménage avec presse
carro plástico con prensa



Körper · block · corps · cuerpo: PP/ALU

Maße · size · mesure · medidas/mm: 630 x 400 x 490/690

Anwendung · use · usage · uso:

2 Eimer mit je 15 l, mit Mopp-Pressse · 2 buckets with each 15 l, with plastic wringer · 2 seaux avec chaque 15 l, avec presse verticale à mâchoires · 2 baldes de 15 l, con prensa para mopas



8965

Wischmopp-Pressse
plastic wringer
presse verticale à mâchoires
prensa plástica



Körper · block · corps · cuerpo: PP/ALU

Maße · size · mesure · medidas/mm: 230 x 220 x 340

Anwendung · use · usage · uso:

verstärkter Hebel · strengthened handle · axe de passage renforcé · mango reforzado

HACCP



8968

Fahreimer mit Mopp-Pressse
plastic mop trolley with wringer
chariot de ménage avec presse
carro plástico con prensa



Körper · block · corps · cuerpo: PP/Chrom

Maße · size · mesure · medidas/mm: 630 x 400 x 490/690

Anwendung · use · usage · uso:

2 Eimer mit je 25 l, mit Mopp-Pressse · 2 buckets with each 25 l, with plastic wringer · 2 seaux avec chaque 25 l, avec presse verticale à mâchoires · 2 baldes de 25 l, con prensa para mopas



8967

Fahreimer mit Mopp-Pressse
plastic mop trolley with wringer
chariot de ménage avec presse
carro plástico con prensa



*

Körper · block · corps · cuerpo:

PP/Chrom

Maße · size · mesure · medidas/mm:

520 x 420 x 530/740

Anwendung · use · usage · uso:

1 Eimer mit 25 l, mit Mopp-Pressse · 1 bucket with 25 l, with plastic wringer · 1 seau avec 25 l, avec presse verticale à mâchoires · 1 balde de 25 l, con prensa para mopas





**HANDGERÄTE
HAND ARTICLES
OUTILS MANUELS
ARTICULOS DE MANO**



HANDBESEN • HAND-BRUSHES • BALAYETTES • CEPILLOS DE MANO

8893

Handbesen
hand-brush
balayette
cepillo de mano



Körper · block · corps · cuerpo:	PP
Maße · size · mesure · medidas/mm:	350 x 90 x 90
Besatzhöhe · bristle trim · taille garniture · altura cerda/mm:	50
Besatzmaterial · bristle · matériel · material:	PBT Ø 0,25

-20-140°C



88930



FC88931



FC88932



FC88933



FC88934



FC88935



FC88937

8893U

Handbesen
hand-brush
balayette
cepillo de mano



Körper · block · corps · cuerpo:	PP
Maße · size · mesure · medidas/mm:	350 x 90 x 90
Besatzhöhe · bristle trim · taille garniture · altura cerda/mm:	50
Besatzmaterial · bristle · matériel · material:	PBT Ø 0,25

-20-140°C



88930U



FC88931U



FC88932U



FC88933U



FC88934U



FC88935U



FC88937U

8894

Handbesen
hand-brush
balayette
cepillo de mano



Körper · block · corps · cuerpo:	PP
Maße · size · mesure · medidas/mm:	350 x 90 x 90
Besatzhöhe · bristle trim · taille garniture · altura cerda/mm:	45
Besatzmaterial · bristle · matériel · material:	PBT Ø 0,50

-20-140°C



88940



FC88941



FC88942



FC88943



FC88944



FC88945



FC88947

8838

Handbesen
hand-brush
balayette
cepillo de mano



Körper · block · corps · cuerpo:	PP
Maße · size · mesure · medidas/mm:	285 x 20 x 85
Besatzhöhe · bristle trim · taille garniture · altura cerda/mm:	50
Besatzmaterial · bristle · matériel · material:	PBT Ø 0,25

-20-140°C



88380



88381



88382



88383



88384

HANDBESEN • HAND-BRUSHES • BALAYETTES • CEPILLOS



<h2>8838U</h2> <p>Handbesen hand-brush balayette cepillo de mano</p>		Körper • block • corps • cuerpo:	PP
		Maße • size • mesure • medidas/mm:	285 x 20 x 85
		Besatzhöhe • bristle trim • taille garniture • altura cerda/mm:	50
		Besatzmaterial • bristle • matériel • material:	PBT Ø 0,25
		-20-140°C HACCP	
88380U	88381U	88382U	88383U
88384U			

<h2>8839</h2> <p>Handbesen hand-brush balayette cepillo de mano</p>		Körper • block • corps • cuerpo:	PP
		Maße • size • mesure • medidas/mm:	285 x 20 x 85
		Besatzhöhe • bristle trim • taille garniture • altura cerda/mm:	45
		Besatzmaterial • bristle • matériel • material:	PBT Ø 0,50
		-20-140°C HACCP	
88390	88391	88392	88393
88394			

<h2>8897</h2> <p>Handbesen hand-brush balayette cepillo de mano</p>		Körper • block • corps • cuerpo:	PP
		Maße • size • mesure • medidas/mm:	340 x 90 x 95
		Besatzhöhe • bristle trim • taille garniture • altura cerda/mm:	45/55
		Besatzmaterial • bristle • matériel • material:	PBT Ø 0,50/0,25
		-20-140°C HACCP	

<h2>8897U</h2> <p>Handbesen hand-brush balayette cepillo de mano</p>		Körper • block • corps • cuerpo:	PP
		Maße • size • mesure • medidas/mm:	340 x 90 x 95
		Besatzhöhe • bristle trim • taille garniture • altura cerda/mm:	45/55
		Besatzmaterial • bristle • matériel • material:	PBT Ø 0,50/0,25
		-20-140°C	

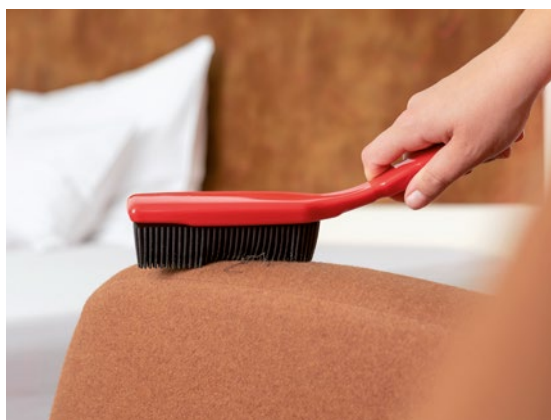

5939

Gumminoppen-Handbesen
rubber hand-brush
balayette caoutchouc
cepillo de mano de goma



Körper · block · corps · cuerpo:	PP
Maße · size · mesure · medidas/mm:	275 x 45 x 70
Besatzhöhe · bristle trim · taille garniture · altura cerda/mm:	30
Besatzmaterial · bristle · matériel · material:	
Weichkautschuk · soft rubber · caoutchouc doux · goma suave	

-10-80°C



8893EXT

Handbesen mit verlängertem Alustiel
hand-brush with extended alu handle
balayette avec manche aluminium allongé
cepillo de mano con mango de aluminio extendido

Körper · block · corps · cuerpo:	PP/ALU
Maße · size · mesure · medidas/mm:	X x 90 x 90
Besatzhöhe · bristle trim · taille garniture · altura cerda/mm:	50
Besatzmaterial · bristle · matériel · material:	PBT Ø 0,25 

zum individuellen Verlängern mit haug Alustielen mit Außen-Ø 25 mm • for individual extension with haug alu handles in Ø 25 mm • à allonger avec tous haug manches en alu avec Ø 25 mm • para extensión individual con mango haug de aluminio de Ø 25 mm

-20-140°C



HACCP



19500

Handbesen
hand-brush
balayette
cepillo de mano



Körper · block · corps · cuerpo:	PP
Maße · size · mesure · medidas/mm:	340 x 90 x 90
Besatzhöhe · bristle trim · taille garniture · altura cerda/mm:	50
Besatzmaterial · bristle · matériel · material:	HM 30/70 

-20-80°C



HACCP



KEHRSCHAUFELN • DUSTPANS • PELLES • PALAS DE MANO



550

Kehrschaufel
dustpan
pelle
pala de mano



Körper · block · corps · cuerpo: INOX
Maße · size · mesure · medidas/mm: 400 x 220 x 75
medidas/mm:

-100-600°C HACCP

177

Kehrschaufel
dustpan
pelle
pala de mano



Körper · block · corps · cuerpo: PP
Maße · size · mesure · medidas/mm: 350 x 222 x 70
Fassungsvermögen · capacity · capacité · capacidad: ~0,8 l / ~800 g

0-80°C HACCP



8942

Kehrschaufel
dustpan
pelle
pala de mano



Körper · block · corps · cuerpo: PP
Maße · size · mesure · medidas/mm: 325 x 330 x 70
Fassungsvermögen · capacity · capacité · capacidad: ~1,0 l / ~1000g

-20-80°C HACCP



KEHRGARNITUREN • DUSTPAN-SETS • PELLES ET BALAYETTES • SETS DE PALA+CEPILLO

8892

Kehrgarnitur
dustpan-set
pelle et balayette
set de pala+cepillo



Körper · block · corps · cuerpo: PP
Maße · size · mesure · medidas/mm: 350 x 222 x 110
Besatzhöhe · bristle trim · taille garniture · altura cerda/mm: 50
Besatzmaterial · bristle · matériel · material: PBT Ø 0,25

0-140°C HACCP



8892U

Kehrgarnitur
dustpan-set
pelle et balayette
set de pala+cepillo



Körper · block · corps · cuerpo: PP
Maße · size · mesure · medidas/mm: 350 x 222 x 110
Besatzhöhe · bristle trim · taille garniture · altura cerda/mm: 50
Besatzmaterial · bristle · matériel · material: PBT Ø 0,25

0-140°C HACCP

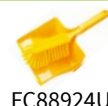



8896

Kehrgarnitur
dustpan-set
pelle et balayette
set de pala+cepillo



Körper · block · corps · cuerpo: PP
Maße · size · mesure · medidas/mm: 355 x 222 x 110
Besatzhöhe · bristle trim ·
taille garniture · altura cerda/mm: 45/55
Besatzmaterial · bristle ·
matériel · material: PBT Ø 0,50/0,25



0-140°C



8896U

Kehrgarnitur
dustpan-set
pelle et balayette
set de pala+cepillo



Körper · block · corps · cuerpo: PP
Maße · size · mesure · medidas/mm: 355 x 222 x 110
Besatzhöhe · bristle trim ·
taille garniture · altura cerda/mm: 45/55
Besatzmaterial · bristle ·
matériel · material: PBT Ø 0,50/0,25



0-140°C



1950

Kehrgarnitur
dustpan-set
pelle et balayette
set de pala+cepillo



Körper · block · corps · cuerpo: PP
Maße · size · mesure · medidas/mm: 350 x 222 x 110
Besatzhöhe · bristle trim ·
taille garniture · altura cerda/mm: 50
Besatzmaterial · bristle ·
matériel · material: HM 30/70



0-80°C



3500

Kehrgarnitur flexibel
dustpan-set flexible
pelle et balayette flexible
set de pala+cepillo flexible



Körper · block · corps · cuerpo: PP/TPE
Maße · size · mesure · medidas/mm: 275 x 247 x 10
Besatzhöhe · bristle trim ·
taille garniture · altura cerda/mm: 49
Besatzmaterial · bristle ·
matériel · material: PET Ø 0,20



0-80°C



593

Gumminoppen-Kehrgarnitur
rubber dustpan-set
pelle et balayette caoutchouc
set de pala + cepillo de goma



Körper · block · corps · cuerpo: PP
Maße · size · mesure · medidas/mm: 365 x 250 x 100
Besatzhöhe · bristle trim ·
taille garniture · altura cerda/mm: 30
Besatzmaterial · bristle · matériel · material: Weichkautschuk · soft rubber · caoutchouc doux · goma suave



-10-80°C



KEHRGARNITUREN + KEHRER • DUSTPAN-SETS + SWEEPERS • PELLES ET BALAYETTES + BALAIS MÉCANIQUES • SETS DE PALA + CEPILLO + ESCOBA Y BARREDORAS



 **ANWENDUNGSVIDEO**
APPLICATION VIDEO
VIDÉO DE DÉMONSTRATION
VÉDEO DE APLICACIÓN

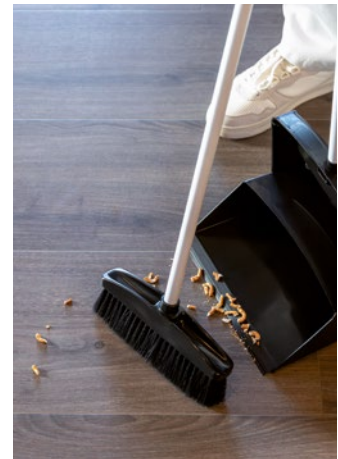

1990

Kehrgarnitur mit
langem Stahlstiel
lobby dustpan-set
with long metal handle
pelle et balayette avec
manche long en métal
set de pala basculante+
escoba con mango largo
de metal



19901 19902 1990

Körper • block • corps • cuerpo: PP/FE
Maße • size • mesure • medidas/mm: 85 x 250 x 1080
Besatzhöhe • bristle trim • taille garniture • altura cerda/mm: 60
Besatzmaterial • bristle • matériel • material: PET Ø 0,20

-20-130°C



19920

Kehrgarnitur mit
langem Stahlstiel
lobby dustpan-set
with long metal handle
pelle et balayette avec
manche long en métal
set de pala basculante+
escoba con mango largo
de metal



Körper • block • corps • cuerpo: PP/FE
Maße • size • mesure • medidas/mm: 85 x 250 x 1080
Besatzhöhe • bristle trim • taille garniture • altura cerda/mm: 60
Besatzmaterial • bristle • matériel • material: PET Ø 0,60

-20-130°C



8999

Kehrgarnitur mit langem
Stahlstiel und Rollen
lobby dustpan-set with long
metal handle and rollers
pelle et balayette avec
manche long en métal
et rôles
set de pala basculante+
escoba con mango largo
de metal y rollos



Körper • block • corps • cuerpo: PP/FE
Maße • size • mesure • medidas/mm: 140 x 330 x 950
Besatzhöhe • bristle trim • taille garniture • altura cerda/mm: 90
Besatzmaterial • bristle • matériel • material: PVC Ø 0,30-0,45

0-60°C





8996

Kehrgarnitur mit langem Alustiel
lobby dustpan-set with long alu handle
pelle et balayette avec manche long en alu
set de pala basculante+escoba con mango largo de alu



mit Gummiwischer 320 mm und Abfallbeutelhalter
 with rubber squeegee 320 mm and waste bag holder
 avec un raclette sol 320 mm et un porte-sac poubelle
 con haragán de goma 320 mm y soporte para bolsa de residuos

Körper · block · corps · cuerpo:	PP
Maße · size · mesure · medidas/mm:	160 x 305 x 970
Besatzhöhe · rubber trim · taille garniture · altura goma/mm:	21
Besatzmaterial · rubber quality · matériel · material:	TPE

0-80°C



5201

Teppichkehrer
carpet-sweeper
balai mécanique
barredora para alfombra

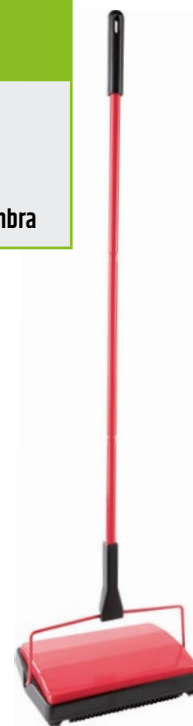

Körper · block · corps · cuerpo:	MET
Maße · size · mesure · medidas/mm:	195 x 275 x 1050
Besatzmaterial · bristle · matériel · material:	reine Borste pure bristle soie pur cerda pura



0-150°C



19930

Besen für Kehrgarnitur 1990
broom für dustpan-set 1990
balai pour pelle et balayette 1990
escoba por set de pala+cepillo 1990



Körper · block · corps · cuerpo:	PP
Maße · size · mesure · medidas/mm:	230 x 40 x 105
Besatzhöhe · bristle trim · taille garniture · altura cerda/mm:	60
Besatzmaterial · bristle · matériel · material:	PET Ø 0,20















-20-130°C



STIELBÜRSTEN · CHURN-BRUSHES · BROSSES À MANCHE · CEPILLOS CON MANGO



8820		Körper · block · corps · cuerpo:	PP
		Maße · size · mesure · medidas/mm:	260 x 72 x 70
Stielbürste mit kurzem Griff churn-brush with short handle brosse à manche court cepillo con mango corto		Besatzhöhe · bristle trim · taille garniture · altura cerda/mm:	35
		Besatzmaterial · bristle · matériel · material:	PBT Ø 0,50 
		-20-140°C	 HACCP  
			
8820	FC88201	FC88202	FC88203
			
			
			
			FC88204
			FC88205
			FC88207

8900		Körper · block · corps · cuerpo:	PP
		Maße · size · mesure · medidas/mm:	400 x 48 x 70
Stielbürste mit langem Griff churn-brush with long handle brosse à manche long cepillo con mango lungo		Besatzhöhe · bristle trim · taille garniture · altura cerda/mm:	35
		Besatzmaterial · bristle · matériel · material:	PBT Ø 0,50 
		-20-140°C	 HACCP  
			
8900	FC89001	FC89002	FC89003
			
			
			
			FC89004
			FC89005
			FC89007

88222		Körper · block · corps · cuerpo:	PP
		Maße · size · mesure · medidas/mm:	260 x 72 x 70
Stielbürste mit kurzem Griff churn-brush with short handle brosse à manche court cepillo con mango corto		Besatzhöhe · bristle trim · taille garniture · altura cerda/mm:	50
		Besatzmaterial · bristle · matériel · material:	PBT Ø 0,25 
		-20-140°C	 HACCP  

8823		Körper · block · corps · cuerpo:	PP
		Maße · size · mesure · medidas/mm:	260 x 72 x 45
Stielbürste mit kurzem Griff churn-brush with short handle brosse à manche court cepillo con mango corto		Besatzhöhe · bristle trim · taille garniture · altura cerda/mm:	20
		Besatzmaterial · bristle · matériel · material:	 Ø 0,25 mm Messingdraht · brass wire · fil de laiton · alambre de latón
		-20-600°C	 HACCP  



88242

**Stielbürste mit kurzem Griff
mit Wasserdurchlauf**
churn-brush with short handle
with waterchannel
brosse à manche court
avec passage d'eau
cepillo con mango corto
con paso de agua



Körper · block · corps · cuerpo:	PP/TPE
Maße · size · mesure · medidas/mm:	295 x 75 x 75
Besatzhöhe · bristle trim · taille garniture · altura cerda/mm:	45
Besatzmaterial · bristle · matériel · material:	PBT Ø 0,30 

-20-140°C



HACCP



8825

Auto-Waschbürste mit kurzem Griff
car-washing-brush with short handle
brosse de lavage de voiture
à manche court
cepillo de lavado de coches
con mango corto



Körper · block · corps · cuerpo:	PP
Maße · size · mesure · medidas/mm:	260 x 72 x 65
Besatzhöhe · bristle trim · taille garniture · altura cerda/mm:	50
Besatzmaterial · bristle · matériel · material:	PVC Ø 0,25 

-20-60°C



88252

Felgen- & Reifenbürste mit kurzem Griff
car-wheel & tire-brush with short handle
brosse des jantes & pneus
à manche court
cepillo para llantas & neumáticos
con mango corto



Körper · block · corps · cuerpo:	PP
Maße · size · mesure · medidas/mm:	260 x 72 x 75
Besatzhöhe · bristle trim · taille garniture · altura cerda/mm:	45
Besatzmaterial · bristle · matériel · material:	PP Ø 0,30 

-20-80°C

HACCP



8820EXT

**Stielbürste mit kurzem Griff
mit verlängertem Alustiel**
churn-brush with short handle
with extended alu handle
brosse à manche court
avec manche aluminium allongé
cepillo con mango corto
con mango de aluminio extendido

Körper · block · corps · cuerpo:	PP/ALU
Maße · size · mesure · medidas/mm:	X x 72 x 70
Besatzhöhe · bristle trim · taille garniture · altura cerda/mm:	35
Besatzmaterial · bristle · matériel · material:	PBT Ø 0,50 

zum individuellen Verlängern mit haug Alustielen mit Außen-Ø 25 mm • for individual extension with haug alu handles in Ø 25 mm • à allonger avec tous haug manches en alu avec Ø 25 mm • para extensión individual con mango haug de aluminio de Ø 25 mm

-20-140°C



HACCP



89012

Stielbürste mit langem Griff
churn-brush with long handle
brosse à manche long
cepillo con mango lungo



Körper · block · corps · cuerpo:	PP
Maße · size · mesure · medidas/mm:	400 x 48 x 85
Besatzhöhe · bristle trim · taille garniture · altura cerda/mm:	50
Besatzmaterial · bristle · matériel · material:	PBT Ø 0,25 

-20-140°C



HACCP



8900EXT

Stielbürste mit langem Griff
mit verlängertem Alustiel
churn-brush with long handle
with extended alu handle
brosse à manche long avec
manche aluminium allongé
cepillo con mango lungo con
mango de aluminio extendido

- zum individuellen Verlängern mit haug Alustielen mit Außen-Ø 25 mm
- for individual extension with haug alu handles in Ø 25 mm
- à allonger avec tous haug manches en alu avec Ø 25 mm
- para extensión individual con mango haug de aluminio de Ø 25 mm

Körper · block · corps · cuerpo:	PP
Maße · size · mesure · medidas/mm:	X x 48 x 85
Besatzhöhe · bristle trim · taille garniture · altura cerda/mm:	50
Besatzmaterial · bristle · matériel · material:	PBT Ø 0,25 

-20-140°C



HACCP



(Stiele S. 32-41 · handles p. 32-41 · manches p. 32-41 · mangos p. 32-41)

8903

Stielbürste mit langem Griff
churn-brush with long handle
brosse à manche long
cepillo con mango lungo



Körper · block · corps · cuerpo:	PP
Maße · size · mesure · medidas/mm:	400 x 48 x 32
Besatzhöhe · bristle trim · taille garniture · altura cerda/mm:	20
Besatzmaterial · bristle · matériel · material:	 Ø 0,25 mm Messingdraht · brass wire · fil de laiton · alambre de latón

-20-600°C



HACCP



145

Stielbürste schmal
handle-brush slim
brosse à manche étroite
cepillo con mango estrecho



Körper · block · corps · cuerpo:	PP
Maße · size · mesure · medidas/mm:	310 x 30 x 55
Besatzhöhe · bristle trim · taille garniture · altura cerda/mm:	23
Besatzmaterial · bristle · matériel · material:	PBT Ø 0,35 

-20-140°C



HACCP



1450



FC1451



FC1452



FC1453



FC1454



FC1455



FC1457

146

Stielbürste breit
handle-brush large
brosse à manche large
cepillo con mango ancho



Körper · block · corps · cuerpo:	PP
Maße · size · mesure · medidas/mm:	315 x 50 x 55
Besatzhöhe · bristle trim · taille garniture · altura cerda/mm:	23
Besatzmaterial · bristle · matériel · material:	PBT Ø 0,35 

-20-140°C



HACCP



1460



FC1461



FC1462



FC1463



FC1464



FC1465



FC1467

STIELBÜRSTEN • CHURN-BRUSHES • BROSSES À MANCHE • CEPILLOS CON MANGO



6050

Stielbürste mit Griff
handle-brush
brosse à manche
cepillo con mango



Körper · block · corps · cuerpo: PP
Maße · size · mesure · medidas/mm: 290 x 45 x 70
Besatzhöhe · bristle trim ·
taille garniture · altura cerda/mm: 24
Besatzmaterial · bristle · matériel · material: PBT Ø 0,25

-20-140°C



HACCP



60500



FC60501



FC60502



FC60503



FC60504

607

Stielbürste mit kurzem Griff
handle-brush with short handle
brosse à manche court
cepillo con mango corto



Körper · block · corps · cuerpo: PP
Maße · size · mesure · medidas/mm: 275 x 47 x 40
Besatzhöhe · bristle trim ·
taille garniture · altura cerda/mm: 27
Besatzmaterial · bristle · matériel · material: PBT Ø 0,50

-20-140°C



HACCP



6070



FC60701



FC60702



FC60703



FC60704

6080

Stielbürste mit Griff
handle-brush
brosse à manche
cepillo con mango



Körper · block · corps · cuerpo: PP
Maße · size · mesure · medidas/mm: 290 x 45 x 70
Besatzhöhe · bristle trim ·
taille garniture · altura cerda/mm: 24
Besatzmaterial · bristle · matériel · material: PBT Ø 0,50

-20-140°C



HACCP



6100

Grillbürste
grill-cleaning-brush
brosse à barbecue
cepillo para parrilla



Körper · block · corps · cuerpo: PP
Maße · size · mesure · medidas/mm: 295 x 48 x 70
Besatzhöhe · bristle trim ·
taille garniture · altura cerda/mm: 19
Besatzmaterial · bristle · matériel · material: Ø 0,25 mm Messingdraht · brass wire · fil de laiton · alambre de latón

-20-600°C



HACCP



8837

Drahtbürste
wire-brush
brosse métallique
cepillo de alambre



Körper · block · corps · cuerpo: PP
Maße · size · mesure · medidas/mm: 285 x 30 x 48
Besatzhöhe · bristle trim ·
taille garniture · altura cerda/mm: 26
Besatzmaterial · bristle · matériel · material: V4A INOX Ø 0,30

-20-600°C



HACCP



369

Polsterbürste
upholstery-brush
brosse à tapisserie
cepillo de tapiceria



Körper · block · corps · cuerpo: PP
Maße · size · mesure · medidas/mm: 275 x 47 x 36
Besatzhöhe · bristle trim ·
taille garniture · altura cerda/mm: 23
Besatzmaterial · bristle · matériel · material: PP Ø 0,35

-20-80°C



FUGENBÜRSTEN • JOINT-BRUSHES • BROSSES JOINTS • CEPILLOS ARTICULADOS













 **ANWENDUNGSVIDEO**
APPLICATION VIDEO
VIDÉO DE DÉMONSTRATION
VÍDEO DE APLICACIÓN



 **ANWENDUNGSVIDEO**
APPLICATION VIDEO
VIDÉO DE DÉMONSTRATION
VÍDEO DE APLICACIÓN



<h2>8392</h2> <p>Fugenbürste joint-brush brosse joints cepillo articulado</p>		<p>Körper • block • corps • cuerpo: PP</p>				
		<p>Maße • size • mesure • medidas/mm: 220 x 15 x 45</p> <p>Besatzhöhe • bristle trim • taille garniture • altura cerda/mm: 19</p> <p>Besatzmaterial • bristle • matériel • material: PBT Ø 0,50</p> 				
    						
 83920	 FC83921	 FC83922	 FC83923	 FC83924	 FC83925	 FC83927

<h2>8393</h2> <p>Tastaturbürste keyboard-brush brosse à clavier cepillo de teclado</p>		<p>Körper • block • corps • cuerpo: PP</p>
		<p>Maße • size • mesure • medidas/mm: 220 x 15 x 45</p> <p>Besatzhöhe • bristle trim • taille garniture • altura cerda/mm: 19</p> <p>Besatzmaterial • bristle • matériel • material: PBT Ø 0,25</p> 
    		



<h2>8394</h2> <p>Fugenbürste joint-brush brosse joints cepillo articulado</p>		<p>Körper • block • corps • cuerpo: PP</p>
		<p>Maße • size • mesure • medidas/mm: 220 x 15 x 45</p> <p>Besatzhöhe • bristle trim • taille garniture • altura cerda/mm: 16</p> <p>Besatzmaterial • bristle • matériel • material:  </p> <p>Ø 0,18 mm Messingdraht • brass wire • fil de laiton • alambre de latón</p>
   		









8395		Körper · block · corps · cuerpo:	PP
		Maße · size · mesure · medidas/mm:	220 x 15 x 45
Fugenbürste joint-brush brosse joints cepillo articulado		Besatzhöhe · bristle trim · taille garniture · altura cerda/mm:	16
		Besatzmaterial · bristle · matériel · material:	V4A INOX Ø 0,18 
		-20-600°C	 HACCP   10

8836		Körper · block · corps · cuerpo:	PP/V4A
		Maße · size · mesure · medidas/mm:	228 x 12 x 32
Fugenbürste joint-brush brosse joints cepillo articulado		Besatzhöhe · bristle trim · taille garniture · altura cerda/mm:	16
		Besatzmaterial · bristle · matériel · material:	PP Ø 0,40/V4A 
		Edelstahlschiene · stainless steel bar · bande en acier inox · banda de acero inox	
		-20-80°C	 HACCP  10

88362		Körper · block · corps · cuerpo:	PP/V4A
		Maße · size · mesure · medidas/mm:	228 x 12 x 32
Fugenbürste joint-brush brosse joints cepillo articulado		Besatzhöhe · bristle trim · taille garniture · altura cerda/mm:	16
		Besatzmaterial · bristle · matériel · material:	PP Ø 0,40/V4A 
		Edelstahlschiene · stainless steel bar · bande en acier inox · banda de acero inox	
		-20-80°C	 HACCP  10

8846		Körper · block · corps · cuerpo:	PP
		Maße · size · mesure · medidas/mm:	235 x 35 x 90/310
Fugenbürste mit kurzem Griff joint-brush with short handle brosse joints avec manche court cepillo articulado con mango corto		Besatzhöhe · bristle trim · taille garniture · altura cerda/mm:	25
		Besatzmaterial · bristle · matériel · material:	PP Ø 0,60 
		-20-80°C	 HACCP  10

WASCHBÜRSTEN · HAND-SCRUB-BRUSHES · BROSSES À MAIN · CEPILLOS DE MANO PARA FREGAR



**▶ ANWENDUNGSVIDEO
APPLICATION VIDEO
VIDÉO DE DÉMONSTRATION
VÉDEO DE APLICACIÓN**



604

Waschbürste flexibel
hand-scrub-brush flexible
brosse à main flexible
cepillo de mano para fregar flexible



Körper · block · corps · cuerpo:	PP
Maße · size · mesure · medidas/mm:	190 x 70 x 40
Besatzhöhe · bristle trim · taille garniture · altura cerda/mm:	25
Besatzmaterial · bristle · matériel · material:	PBT Ø 0,35

0-60°C  HACCP  

 6040
  FC6041
  FC6042
  FC6043
  FC6044
  FC6045
  FC6047

8830

Waschbürste rund
hand-scrub-brush round
brosse à main ronde
cepillo de mano redondo para fregar



Körper · block · corps · cuerpo:	PP
Maße · size · mesure · medidas/mm:	205 x 65 x 55
Besatzhöhe · bristle trim · taille garniture · altura cerda/mm:	30
Besatzmaterial · bristle · matériel · material:	PBT Ø 0,50

0-140°C  HACCP  

 8830
  FC88301
  FC88302
  FC88303
  FC88304
  FC88305
  FC88307

6010

Scheuerbürste mit Bügel
scrubbing-brush with handle
brosse à main avec manche
cepillo para fregar con asa



Körper · block · corps · cuerpo:	PP
Maße · size · mesure · medidas/mm:	180 x 48 x 70
Besatzhöhe · bristle trim · taille garniture · altura cerda/mm:	22
Besatzmaterial · bristle · matériel · material:	PBT Ø 0,50

-20-140°C  HACCP  

 6010
  FC60101
  FC60102
  FC60103
  FC60104
  FC60105
  FC60107



**▶ ANWENDUNGSVIDEO
APPLICATION VIDEO
VIDÉO DE DÉMONSTRATION
VÉDEO DE APLICACIÓN**



8743

Knopfbürste
knob-brush
brosse ronde
cepillo redondo



Körper · block · corps · cuerpo:	PP
Maße · size · mesure · medidas/mm:	Ø 135 x 100
Besatzhöhe · bristle trim · taille garniture · altura cerda/mm:	43
Besatzmaterial · bristle · matériel · material:	PBT Ø 0,50

-20-140°C



HACCP



87430



FC87431



FC87432



FC87433



FC87434



FC87435



FC87437

6030

Waschbürste flexibel
hand-scrub-brush flexible
brosse à main flexible
cepillo de mano para fregar
flexible



Körper · block · corps · cuerpo:	PP
Maße · size · mesure · medidas/mm:	190 x 70 x 40
Besatzhöhe · bristle trim · taille garniture · altura cerda/mm:	25
Besatzmaterial · bristle · matériel · material:	PP Ø 0,35

0-60°C

HACCP



8831

Waschbürste rund
hand-scrub-brush round
brosse à main ronde
cepillo de mano para fregar
redondo



Körper · block · corps · cuerpo:	PP
Maße · size · mesure · medidas/mm:	210 x 70 x 55
Besatzhöhe · bristle trim · taille garniture · altura cerda/mm:	28/36
Besatzmaterial · bristle · matériel · material:	PBT Ø 0,50

0-140°C



HACCP



8832

Waschbürste rund
hand-scrub-brush round
brosse à main ronde
cepillo de mano para fregar
redondo



Körper · block · corps · cuerpo:	PP
Maße · size · mesure · medidas/mm:	205 x 65 x 55
Besatzhöhe · bristle trim · taille garniture · altura cerda/mm:	25/30
Besatzmaterial · bristle · matériel · material:	PBT Ø 0,50

0-140°C



HACCP



8835

Waschbürste rund
hand-scrub-brush round
brosse à main ronde
cepillo de mano para fregar
redondo



Körper · block · corps · cuerpo:	PP
Maße · size · mesure · medidas/mm:	225 x 72 x 55
Besatzhöhe · bristle trim · taille garniture · altura cerda/mm:	28/36
Besatzmaterial · bristle · matériel · material:	PBT Ø 0,60

0-140°C



HACCP



087

Steckdosenbürste
socket-brush
brosse à douille
cepillo de enchufe



Körper · block · corps · cuerpo:	PP
Maße · size · mesure · medidas/mm:	100 x Ø 40
Besatzhöhe · bristle trim · taille garniture · altura cerda/mm:	7
Besatzmaterial · bristle · matériel · material:	Nyl 6.0, Ø 0,15



0-100°C



PINSEL · PASTRY-BRUSHES · PINCEAUX · BROCHAS PARA PASTELERÍAS



1311		Körper · block · corps · cuerpo:	PP
		Maße · size · mesure · medidas/mm:	195 x 27 x 8
Flachpinsel pastry-brush pinceau à pâtisserie brocha para pastelerías		Besatzhöhe · bristle trim · taille garniture · altura cerda/mm:	35
		Besatzmaterial · bristle · matériel · material: Zwinge V2A · clamp V2A · frette V2A · abrazadera V2A	PBT Ø 0,20 
		-20-140°C	 HACCP  

1312		Körper · block · corps · cuerpo:	PP
		Maße · size · mesure · medidas/mm:	195 x 36 x 8
Flachpinsel pastry-brush pinceau à pâtisserie brocha para pastelerías		Besatzhöhe · bristle trim · taille garniture · altura cerda/mm:	38
		Besatzmaterial · bristle · matériel · material: Zwinge V2A · clamp V2A · frette V2A · abrazadera V2A	PBT Ø 0,20 
		-20-140°C	 HACCP  

8300		Körper · block · corps · cuerpo:	PP/INOX
		Maße · size · mesure · medidas/mm:	210 x 35 x 8
Flachpinsel pastry-brush pinceau à pâtisserie brocha para pastelerías		Besatzhöhe · bristle trim · taille garniture · altura cerda/mm:	45
		Besatzmaterial · bristle · matériel · material: Zwinge V2A · clamp V2A · frette V2A · abrazadera V2A	PBT Ø 0,25 
		-20-140°C	 HACCP  

8301		Körper · block · corps · cuerpo:	PP/INOX
		Maße · size · mesure · medidas/mm:	210 x 35 x 8
Flachpinsel pastry-brush pinceau à pâtisserie brocha para pastelerías		Besatzhöhe · bristle trim · taille garniture · altura cerda/mm:	45
		Besatzmaterial · bristle · matériel · material: Zwinge V2A · clamp V2A · frette V2A · abrazadera V2A	PBT Ø 0,25 
		-20-140°C	 HACCP  





8302

Flachpinsel
pastry-brush
pinceau à pâtisserie
brocha para pastelerías





Körper · block · corps · cuerpo:	PP/INOX
Maße · size · mesure · medidas/mm:	225 x 50 x 8
Besatzhöhe · bristle trim · taille garniture · altura cerda/mm:	45
Besatzmaterial · bristle · matériel · material: Zwinge V2A · clamp V2A · frette V2A · abrazadera V2A	PBT Ø 0,25  ▲



-20-140°C  HACCP  

8303

Flachpinsel
pastry-brush
pinceau à pâtisserie
brocha para pastelerías



Körper · block · corps · cuerpo:	PP/INOX
Maße · size · mesure · medidas/mm:	230 x 70 x 10
Besatzhöhe · bristle trim · taille garniture · altura cerda/mm:	50
Besatzmaterial · bristle · matériel · material: Zwinge V2A · clamp V2A · frette V2A · abrazadera V2A	PBT Ø 0,25  ▲



-20-140°C  HACCP  

8310

Flachpinsel
pastry-brush
pinceau à pâtisserie
brocha para pastelerías



Körper · block · corps · cuerpo:	PP/INOX
Maße · size · mesure · medidas/mm:	225 x 50 x 8
Besatzhöhe · bristle trim · taille garniture · altura cerda/mm:	45
Besatzmaterial · bristle · matériel · material: Zwinge V2A · clamp V2A · frette V2A · abrazadera V2A	PBT Ø 0,25  ▲



-20-140°C  HACCP  

8320

Flachpinsel
pastry-brush
pinceau à pâtisserie
brocha para pastelerías



Körper · block · corps · cuerpo:	PP/INOX
Maße · size · mesure · medidas/mm:	230 x 70 x 10
Besatzhöhe · bristle trim · taille garniture · altura cerda/mm:	50
Besatzmaterial · bristle · matériel · material: Zwinge V2A · clamp V2A · frette V2A · abrazadera V2A	PBT Ø 0,25  ▲

-20-140°C  HACCP  



8325

Grillpinsel mit langem Griff
grill-brush with long handle
pinceau à grill avec
manche long
brocha mango largo
para parrillas

Körper · block · corps · cuerpo:	PP
Maße · size · mesure · medidas/mm:	410 x 50 x 40
Besatzhöhe · bristle trim · taille garniture · altura cerda/mm:	42
Besatzmaterial · bristle · matériel · material:	PBT Ø 0,25  ▲

-20-140°C  HACCP  

8111

Spritztüllenbürste
brush for decorating nozzles
brosses pour nettoyer
des douilles à décorer
hisopo para boquillas



Körper · block · corps · cuerpo:	PP
Maße · size · mesure · medidas/mm:	145 x Ø 3/28
Besatzhöhe · bristle trim · taille garniture · altura cerda/mm:	konisch · conical · conique · cónica
Besatzmaterial · bristle · matériel · material:	Nyl 6.6 Ø 0,30 







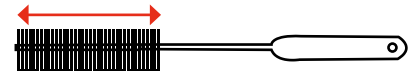





-20-130°C  HACCP  













ROHR- UND SCHLAUCHBÜRSTEN • TUBE- AND HOSE-BRUSHES • ÉCOUVILLONS • HISOPOS PARA MANGUERAS Y TUBOS













MIT V2A EDELSTAHLDRAHT • WITH V2A STAINLESS STEEL WIRE • AVEC FIL D'ACIER INOX V2A • CON ALAMBRE DE ACERO INOXIDABLE V2A



Besatzlänge • bristle length • longueur matériel • largo material

8114		Körper • block • corps • cuerpo:	PP
		Länge • length • longueur • largo/mm:	305
Rohrbürste tube-brush écouvillon hisopo limpia-tubos		Ø/mm:	15
		Besatzlänge • bristle length • longueur matériel • largo material/mm:	80
		Besatzmaterial • bristle • matériel • material:	PBT Ø 0,35 
		-20-140°C	 HACCP  
			
8114	FC81141	FC81142	FC81143
			
FC81144	FC81145	FC81147	

8123		Körper • block • corps • cuerpo:	PP
		Länge • length • longueur • largo/mm:	500
Rohrbürste tube-brush écouvillon hisopo limpia-tubos		Ø/mm:	20
		Besatzlänge • bristle length • longueur matériel • largo material/mm:	120
		Besatzmaterial • bristle • matériel • material:	PBT Ø 050 
		-20-140°C	 HACCP  
			
8123	FC81231	FC81232	FC81233
			
FC81234	FC81235	FC81237	

8124		Körper • block • corps • cuerpo:	PP
		Länge • length • longueur • largo/mm:	500
Rohrbürste tube-brush écouvillon hisopo limpia-tubos		Ø/mm:	40
		Besatzlänge • bristle length • longueur matériel • largo material/mm:	120
		Besatzmaterial • bristle • matériel • material:	PBT Ø 050 
		-20-140°C	 HACCP  
			
8124	FC81241	FC81242	FC81243
			
FC81244	FC81245	FC81247	



8125		Körper · block · corps · cuerpo:	PP			
		Länge · length · longueur · largo/mm:	500			
Rohrbürste tube-brush écouvillon hisopo limpia-tubos		Ø/mm:	60			
		Besatzlänge · bristle length · longueur matériel · largo material/mm:	120			
		Besatzmaterial · bristle · matériel · material:	PBT Ø 0,50 			
		-20-140°C	HACCP			
8125	FC81251	FC81252	FC81253	FC81254	FC81255	FC81257

8126		Körper · block · corps · cuerpo:	PP			
		Länge · length · longueur · largo/mm:	700			
Rohrbürste tube-brush écouvillon hisopo limpia-tubos		Ø/mm:	60			
		Besatzlänge · bristle length · longueur matériel · largo material/mm:	120			
		Besatzmaterial · bristle · matériel · material:	PBT Ø 0,50 			
		-20-140°C	HACCP			
8126	FC81261	FC81262	FC81263	FC81264	FC81265	FC81267

8109		Länge · length · longueur · largo/mm:	505
		Ø/mm:	12
Rohrbürste tube-brush écouvillon hisopo limpia-tubos		Besatzlänge · bristle length · longueur matériel · largo material/mm:	225
		Besatzmaterial · bristle · matériel · material:	Nyl 6.0 Ø 0,10
		-20-100°C	

8112		Länge · length · longueur · largo/mm:	300
		Ø/mm:	20
Reagenzglasbürste test-tube-brush brosse pour éprouvettes hisopo para tubos de ensayo		Besatzlänge · bristle length · longueur matériel · largo material/mm:	105
		Besatzmaterial · bristle · matériel · material:	PBT Ø 0,20
		-20-140°C	HACCP

8113		Länge · length · longueur · largo/mm:	300
		Ø/mm:	35/25
Reagenzglasbürste test-tube-brush brosse pour éprouvettes hisopo para tubos de ensayo		konisch · conical · conique · cónica	
		Besatzlänge · bristle length · longueur matériel · largo material/mm:	100
		Besatzmaterial · bristle · matériel · material:	PBT Ø 0,20
		-20-140°C	HACCP

ROHR- UND SCHLAUCHBÜRSTEN • TUBE- AND HOSE-BRUSHES • ÉCOUVILLONS • HISOPOS PARA MANGUERAS Y TUBOS

MIT V2A EDELSTAHLDRAHT • WITH V2A STAINLESS STEEL WIRE • AVEC FIL D'ACIER INOX V2A • CON ALAMBRE DE ACERO INOXIDABLE V2A



81161

Rohrbürste
tube-brush
écouvillon
hisopo limpia-tubos

Länge · length · longueur · largo/mm:	500
Ø/mm:	40
Besatzlänge · bristle length · longueur matériel · largo material/mm:	100
Besatzmaterial · bristle · matériel · material:	Nyl 6.0 Ø 0,35 

-20-100°C  HACCP 



81162

Rohrbürste
tube-brush
écouvillon
hisopo limpia-tubos

Länge · length · longueur · largo/mm:	450
Ø/mm:	25
Besatzlänge · bristle length · longueur matériel · largo material/mm:	85
Besatzmaterial · bristle · matériel · material:	Nyl 6.0 Ø 0,35 

-20-100°C  HACCP 

81163

Rohrbürste
tube-brush
écouvillon
hisopo limpia-tubos





Länge · length · longueur · largo/mm:	365
Ø/mm:	25
Besatzlänge · bristle length · longueur matériel · largo material/mm:	90
Besatzmaterial · bristle · matériel · material:	 reine Borste · pure bristle · soie pure · cerda pura



0-150°C 

81164

Rohr- und Schlauchbürste
tube- and hose-brush
écouvillon
hisopo limpia-tubos





Länge · length · longueur · largo/mm:	350
Ø/mm:	5
Besatzlänge · bristle length · longueur matériel · largo material/mm:	50
Besatzmaterial · bristle · matériel · material:	PBT Ø 0,20 



-20-140°C  HACCP  

81165

Rohr- und Schlauchbürste
tube- and hose-brush
écouvillon
hisopo limpia-tubos



Länge · length · longueur · largo/mm:	340
Ø/mm:	12
Besatzlänge · bristle length · longueur matériel · largo material/mm:	80
Besatzmaterial · bristle · matériel · material:	Nyl 6.0 Ø 0,20 



-20-100°C  HACCP 



81166

Rohr- und Schlauchbürste
tube- and hose-brush
écouvillon
hisopo limpia-tubos

2 Bürstenenden
brushes both ends
brosses les 2 bouts
cepillos en ambos extremos



Länge · length · longueur · largo/mm:	470
Ø/mm:	14/8
Besatzlänge · bristle length · longueur matériel · largo material/mm:	25/35
Besatzmaterial · bristle · matériel · material:	Nyl 6.0 Ø 0,15  

-20-100°C  HACCP 

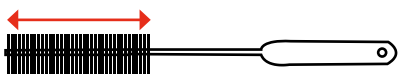

Besatzlänge • bristle length •
longueur matériel • largo material

für Strohhalme • for straws • pour pailles • para pajitas

81169

Strohalm-Reinigungsbürste
brush for cleaning straws
brosse pour nettoyer
des pailles
hisopo para pajitas

Länge • length • longueur • largo/mm: 320

Ø/mm: 8

Besatzlänge • bristle length •
longueur matériel • largo material/mm:

Besatzmaterial • bristle • matériel • material:

Nyl 6.0 Ø 0,15  |

-20-100°C



HACCP



81167

Düsenbürsten-Set
nozzle-brushes set
brosse à buse
hisopo de boquilla

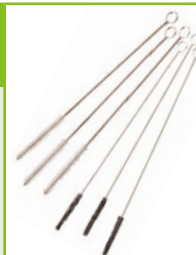

Länge • length • longueur • largo/mm: 100

Ø/mm: 3,5/2,5

Besatzlänge • bristle length • longueur
matériel • largo material/mm:

Besatzmaterial • bristle •
matériel • material: Nyl 6.0 Ø 0,15



-20-100°C



HACCP

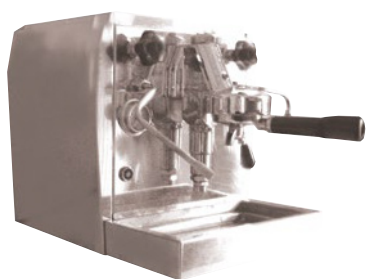

8119

Zitzenbürste
brush for cleaning
milking machines
brosse pour trayeuses
hisopo limpia-ordeñadoras



Körper • block • corps • cuerpo: PP

Maße • size • mesure •
medidas/mm: 500

Ø/mm: 10-56

Besatzlänge • bristle length •
longueur matériel •
largo material/mm: 310

Besatzmaterial • bristle • matériel • material:

PBT Ø 0,35    |

-20-140°C



HACCP



8117

Rohr- und Schlauchbürste
tube- and hose-brush
écouvillon
hisopo limpia-tubos

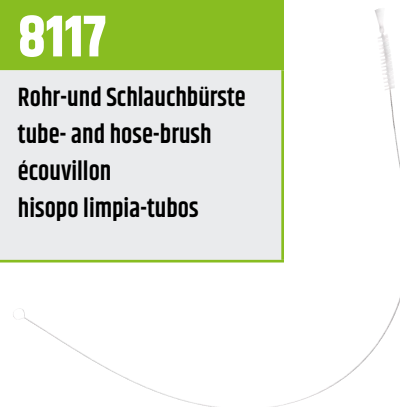

Länge • length •
longueur • largo/mm: 1210

Ø/mm: 15

Besatzlänge • bristle length •
longueur matériel •
largo material/mm: 115

Besatzmaterial • bristle •
matériel • material: Nyl 6.0 Ø 0,25



-20-100°C



HACCP



8115

Espressomaschinen-
Reinigungsset 4-teilig
espresso machine
cleaning set 4 pcs.
set pour nettoyer des
machines espresso 4 pcs.
set de limpieza para
máquinas de espresso
4 pzas.



210 x 140 x 11

Maße • size • mesure •
medidas/mm:

Ø/mm: 3,5/2,5

Besatzlänge • bristle length • longueur
matériel • largo material/mm:

Besatzmaterial • bristle •
matériel • material: Nyl 6.0 Ø 0,15

-20-100°C



-20-140°C



HACCP



0-80°C



2 Düsenbürsten • 2 nozzle-
brushes • 2 écouvillons •
2 cepillos boquillas

1 Rohr-/Schlauchbürste •
1 hose-brush • 1 écouvillon •
1 cepillo-manguera

1 Kaffeesatz-/Staubpinsel • 1 coffee
grounds brush • 1 pinceau pour marc
de café • 1 cepillo para restos de café

350

5

50

PBT Ø 0,20



220 x 23 x 5

30

Rinderhaar • cattle hair • poil
de bovin • pelo de bovino



ROHR- UND SCHLAUCHBÜRSTEN • TUBE- AND HOSE-BRUSHES • ÉCOUVILLONS • HISOPOS PARA MANGUERAS Y TUBOS

MIT V2A EDELSTAHLDRAHT VERLÄNGERBAR • WITH V2A STAINLESS STEEL WIRE EXTENSIONABLE • FIL D'ACIER INOX V2A ALLONGABLES • CON ALAMBRE ACERO INOXIDABLE V2A PARA EXTENSIÓN

8130

Rohrbürste
tube-brush
écouvillon
hisopo limpia-tubos

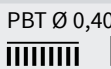

Maße · size · mesure · medidas/mm:	220 x Ø 12
Besatzlänge · bristle length · longueur matériel · largo material/mm:	175
Besatzmaterial · bristle · matériel · material:	PBT Ø 0,40 
Gewinde · thread · fil · hilo:	M5

-20-140°C 

8131

Rohrbürste
tube-brush
écouvillon
hisopo limpia-tubos



Maße · size · mesure · medidas/mm:	220 x Ø 60
Besatzlänge · bristle length · longueur matériel · largo material/mm:	175
Besatzmaterial · bristle · matériel · material:	PBT Ø 0,40 
Gewinde · thread · fil · hilo:	M5

-20-140°C 

8138

Verlängerung für verlängerbare Rohr- und Kugelbürsten
extension for extensionable tube- and ball-brushes
allonge pour écouvillons allongables
extension para hisopos limpia-tubos extensibles

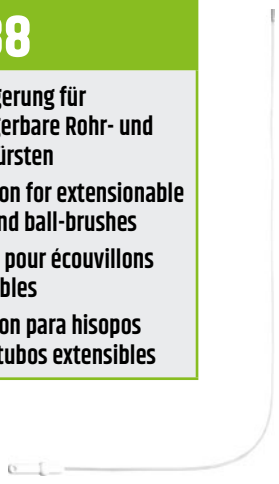

Körper · block · corps · cuerpo:	PP/PA
Maße · size · mesure · medidas/mm:	1500 x Ø 6
Material · material · matériel · material:	PA mit PP Griff · PA with PP handle · PA avec PP manche · PA con mango PP
Gewinde · thread · fil · hilo:	M5

-20-100°C 





- Ø in 5 mm Schritten + Härte S/M/H wählbar
- Ø in 5 mm increments + stiffness S/M/H selectable
- Ø de 5 mm + dureté S/M/H au choix
- incrementos de Ø 5 mm + dureza S/M/H a elección

z. B. 8135S30 = 8135 soft 30 mm, 8135S35, 8135S40,....- 8135S105, 8135M30, 8135M35, 8135M40,....- 8135M105, 8135H30, 8135H35, 8135H40,....- 8135H105

8135

Kugelbürste
ball-brush
brosse boule
hisopo bola

Körper · block · corps · cuerpo:	PP
Maße · size · mesure · medidas/mm:	30-105
Besatzmaterial · bristle · matériel · material:	PBT 
Gewinde · thread · fil · hilo:	M5

-20-140°C 

8139

Verlängerung für verlängerbare Rohr- und Kugelbürsten
extension for extensionable tube- and ball-brushes
allonge pour écouvillons allongables
extension para hisopos limpia-tubos extensibles

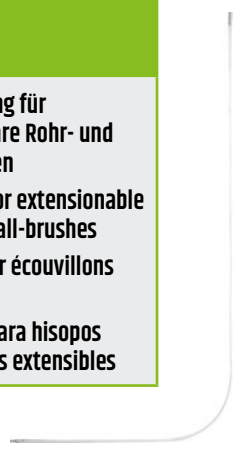

Körper · block · corps · cuerpo:	PA
Maße · size · mesure · medidas/mm:	1500 x Ø 6
Material · material · matériel · material:	ohne Griff · without handle · sans manche · sin mango
Gewinde · thread · fil · hilo:	M5

-20-100°C 

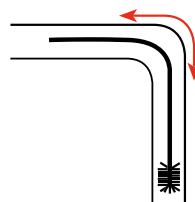
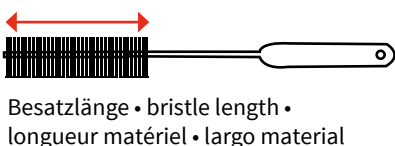



81168

Rohrbürste gestanz
tube-brush punched head
écouvillon estampé
hisopo limpia-tubos



Körper · block · corps · cuerpo: PP
Maße · size · mesure · medidas/mm: 390 x Ø 82
Besatzhöhe · bristle trim · taille garniture · altura cerda/mm: 30
Besatzlänge · bristle length · longueur matériel · largo material/mm: 145
Besatzmaterial · bristle · matériel · material: Nyl 6.0 Ø 0,35

-20-100°C



HACCP



- Lieferung mit Adapter mit Ⓞ Schraubgewinde
- delivery with adapter with Ⓞ thread
- livraison avec adaptateur avec Ⓞ vissage
- entrega con adaptador con Ⓞ rosca-hilo

8908

Rohrbürste gestanz
tube-brush punched head
écouvillon estampé
hisopo limpia-tubos



Körper · block · corps · cuerpo: PP
Maße · size · mesure · medidas/mm: 175 x Ø 70
Besatzhöhe · bristle trim · taille garniture · altura cerda/mm: 20
Besatzlänge · bristle length · longueur matériel · largo material/mm: 145
Besatzmaterial · bristle · matériel · material: PBT Ø 0,50

-20-140°C



HACCP



8909

Rohrbürste gestanz
tube-brush punched head
écouvillon estampé
hisopo limpia-tubos



Körper · block · corps · cuerpo: PP
Maße · size · mesure · medidas/mm: 180 x Ø 82
Besatzhöhe · bristle trim · taille garniture · altura cerda/mm: 25
Besatzlänge · bristle length · longueur matériel · largo material/mm: 150
Besatzmaterial · bristle · matériel · material: PBT Ø 0,50

-20-140°C



HACCP



8909 + 07195

8910

Rohrbürste gestanz
tube-brush punched head
écouvillon estampé
hisopo limpia-tubos



Körper · block · corps · cuerpo: PP
Maße · size · mesure · medidas/mm: 190 x Ø 98
Besatzhöhe · bristle trim · taille garniture · altura cerda/mm: 35
Besatzlänge · bristle length · longueur matériel · largo material/mm: 160
Besatzmaterial · bristle · matériel · material: PBT Ø 0,50

-20-140°C



HACCP



8911

Rohrbürste gestanz
tube-brush punched head
écouvillon estampé
hisopo limpia-tubos



Körper · block · corps · cuerpo: PP
Maße · size · mesure · medidas/mm: 200 x Ø 114
Besatzhöhe · bristle trim · taille garniture · altura cerda/mm: 45
Besatzlänge · bristle length · longueur matériel · largo material/mm: 165
Besatzmaterial · bristle · matériel · material: PBT Ø 0,50

-20-140°C



HACCP



8717

Griff für Rohrbürsten*
handle for tube-brushes*
manche pour écouvillons*
mango para hisopos limpia-tubos*



*8908 / 8909 / 8910 / 8911

Körper · block · corps · cuerpo: PP
Maße · size · mesure · medidas/mm: 220 x Ø 25

-20-80°C



HACCP



E1100017-000

Adapter für Rohrbürsten*
adapter for tube-brushes*
adaptateur pour écouvillons*
adaptador para hisopos limpia-tubos*



*8908 / 8909 / 8910 / 8911

Körper · block · corps · cuerpo: PP
Maße · size · mesure · medidas/mm: 37 x Ø 32

Anwendung · use · usage · uso:
für alle Ⓞ Stiele · for all Ⓞ handles · pour tous manches avec Ⓞ · para todos los mangos con Ⓞ

0-80°C



HACCP



ROHR-, FLASCHEN- UND GLÄSERBÜRSTEN • TUBE-, BOTTLE- AND GLASS-BRUSHES • ÉCOUVILLONS ET BROSSES POUR BOUTEILLES ET VERRES • HISOPOS PARA CRISTALERÍA, BOTELLAS Y TUBOS

1120

Waschbeckenüberlaufbürste
special cleaning brush
for overflow-drain
brosse spéciale pour
nettoyer des trop-pleins
cepillo de limpieza especial
para lavamanos



Körper · block · corps · cuerpo: PP
Maße · size · mesure · medidas/mm: 145 x 50/35 x Ø 25
Besatzmaterial · bristle · matériel · material:
reine Borste · pure bristle · soie pure · cerda pura



0-150°C



118

Babyflaschenbürste
baby-bottle-brush
brosse à biberons
hisopo para mamaderas



Körper · block · corps · cuerpo: PP
Maße · size · mesure · medidas/mm: 310 x Ø 50
Besatzlänge · bristle length · longueur matériel · largo material/mm: 145

Besatzmaterial · bristle · matériel · material: Nyl 6.0 Ø 0,35



-20-100°C

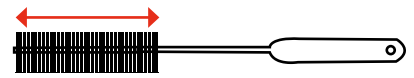

Besatzlänge · bristle length · longueur matériel · largo material



119

Babyflaschenbürste
baby-bottle-brush
brosse à biberons
hisopo para mamaderas



Körper · block · corps · cuerpo: PP
Maße · size · mesure · medidas/mm: 320 x Ø 50
Besatzhöhe · bristle trim · taille garniture · altura cerda/mm: 17

Besatzlänge · bristle length · longueur matériel · largo material/mm: 65

Besatzmaterial · bristle · matériel · material: Nyl 6.6 Ø 0,30



-20-130°C



HACCP



120

Flaschenbürste
bottle-brush
goupillon
hisopo limpia-botellas



Körper · block · corps · cuerpo: PP
Maße · size · mesure · medidas/mm: 390 x Ø 40/60
Besatzlänge · bristle length · longueur matériel · largo material/mm: 150
Besatzmaterial · bristle · matériel · material: Nyl 6.0 Ø 0,35



-20-100°C



124

Flaschenbürste
bottle-brush
goupillon
hisopo limpia-botellas



Körper · block · corps · cuerpo: PP
Maße · size · mesure · medidas/mm: 450 x Ø 60
Besatzlänge · bristle length · longueur matériel · largo material/mm: 190
Besatzmaterial · bristle · matériel · material: Nyl 6.0 Ø 0,35



-20-100°C





127L

Thermoskannenbürste
thermos-bottle-brush
brosse pour bouteilles
thermos
hisopo para termos

Körper · block · corps · cuerpo: PP
Maße · size · mesure · medidas/mm: 450 x Ø 60
Besatzlänge · sponge length · longueur matériel · largo material/mm: 75
Besatzmaterial · sponge · matériel · material: Schaumstoff · special sponge · éponge spéciale · esponja especial

-20-90°C



1290

Thermoskannenbürste
thermos-bottle-brush
brosse pour bouteilles
thermos
hisopo para termos

Körper · block · corps · cuerpo: PP
Maße · size · mesure · medidas/mm: 350 x Ø 60
Besatzlänge · sponge length · longueur matériel · largo material/mm: 110
Besatzmaterial · sponge · matériel · material: Schaumstoff · special sponge · éponge spéciale · esponja especial

-20-90°C



8111

Spritzfüllenbürste
brush for decorating nozzles
brosse pour nettoyer des douilles
à décorer
hisopo para boquillas



Körper · block · corps · cuerpo: PP
Maße · size · mesure · medidas/mm: 145 x Ø 3/28
Besatzhöhe · bristle trim · taille garniture · altura cerda/mm: konisch · conical · conique · cónica
Besatzlänge · bristle length · longueur matériel · largo material/mm: 54
Besatzmaterial · bristle · matériel · material: Nyl 6.6 Ø 0,30

Material · material · matériel · material: V2A Edelstahlraht · V2A stainless steel wire · fil d'acier inox V2A · alambre de acero inoxidable V2A

-20-130°C



HACCP



8101

Wollschopfbürste
soft cotton tip brush
écouvillon cotton
hisopo punta algodón
suave



Maße · size · mesure · medidas/mm: 260 x Ø 20

Besatzlänge · bristle length · longueur matériel · largo material/mm: 95

Besatzmaterial · bristle · matériel · material:

reine Borste/Baumwolle · pure bristle/cotton · soie pure/coton · cerda pura/algodón

Material · material · matériel · material: verzinkter Eisendraht · galvanized wire · fil galvanisé · alambre galvanizado

0-90°C



8102

Wollschopfbürste
soft cotton tip brush
écouvillon cotton
hisopo punta algodón
suave



Maße · size · mesure · medidas/mm: 265 x Ø 25

Besatzlänge · bristle length · longueur matériel · largo material/mm: 100

Besatzmaterial · bristle · matériel · material:

reine Borste/Baumwolle · pure bristle/cotton · soie pure/coton · cerda pura/algodón

Material · material · matériel · material: verzinkter Eisendraht · galvanized wire · fil galvanisé · alambre galvanizado

0-90°C



8103

Wollschopfbürste
soft cotton tip brush
écouvillon cotton
hisopo punta algodón
suave



Maße · size · mesure · medidas/mm: 270 x Ø 30

Besatzlänge · bristle length · longueur matériel · largo material/mm: 105

Besatzmaterial · bristle · matériel · material:

reine Borste/Baumwolle · pure bristle/cotton · soie pure/coton · cerda pura/algodón

Material · material · matériel · material: verzinkter Eisendraht · galvanized wire · fil galvanisé · alambre galvanizado

0-90°C



ROHR-, FLASCHEN- UND GLÄSERBÜRSTEN • TUBE-, BOTTLE- AND GLASS-BRUSHES • ÉCOUVILLONS ET BROSSES POUR BOUTEILLES ET VERRES • HISOPOS PARA CRISTALERÍA, BOTELLAS Y TUBOS



8904

Gläserpülgarnitur
glas-washing-set
brosse pour verres
hisopo para lavavajillas

3 tlg. • 3 pcs. • 3 pcs. • 3 pzas.
 à Ø 75 mm



Körper • block • corps • cuerpo:	PP
Maße • size • mesure • medidas/mm:	190 x 100 x 265
Besatzhöhe • bristle trim • taille garniture • altura cerda/mm:	25
Besatzlänge • bristle length • longueur matériel • largo material/mm:	210
Besatzmaterial • bristle • matériel • material:	Nyl 6.0 Ø 0,35

-20-100°C



8905

Gläser- und Flaschenbürste
glass- and bottle-brush
brosse pour verres et bouteilles
hisopo para cristalería y botellas



Körper • block • corps • cuerpo:	PP
Maße • size • mesure • medidas/mm:	320 x Ø 60
Besatzhöhe • bristle trim • taille garniture • altura cerda/mm:	22
Besatzlänge • bristle length • longueur matériel • largo material/mm:	65
Besatzmaterial • bristle • matériel • material:	Nyl 6.6 Ø 0,40

-20-130°C



HACCP



8906

Gläser- und Flaschenbürste
glass- and bottle-brush
brosse pour verres et bouteilles
hisopo para cristalería y botellas



Körper • block • corps • cuerpo:	PP
Maße • size • mesure • medidas/mm:	320 x Ø 70
Besatzhöhe • bristle trim • taille garniture • altura cerda/mm:	30
Besatzlänge • bristle length • longueur matériel • largo material/mm:	70
Besatzmaterial • bristle • matériel • material:	Nyl 6.6 Ø 0,40

-20-130°C







HACCP











HEIZKÖRPERBÜRSTEN · RADIATOR-BRUSHES · BROSSES POUR RADIATEURS · CEPILLOS PARA RADIADORES





113	Körper · block · corps · cuerpo:	PP
	Maße · size · mesure · medidas/mm:	1200
Flach-Heizkörperbürste flat-radiator-brush brosse pour radiateurs plats cepillo para radiadores planos	Ø/mm:	55
	Besatzlänge · bristle length · longueur matériel · largo material/mm:	850
	Besatzmaterial · bristle · matériel · material:	PVC Ø 0,25  
		-20-60°C 

1350	Heizkörperbürste radiator-brush brosse pour radiateurs cepillo para radiadores	
	Körper · block · corps · cuerpo:	PP
	Maße · size · mesure · medidas/mm:	450 x 115
	Ø/mm:	70
	Besatzlänge · bristle length · longueur matériel · largo material/mm:	185
	Besatzmaterial · bristle · matériel · material:	PVC Ø 0,30  
		-20-80°C 

SPÜLBÜRSTEN UND KÜCHENHELFER · DISHWASHING-BRUSHES AND KITCHEN GADGETS · BROSSES À VAISSELLE ET UTENSILES DE CUISINE · CEPILLOS PARA LAVAPLATOS Y UTENSILIOS DE COCINA

158	Spülbürste rund dishwashing-brush round brosse à vaisselle ronde cepillo para lavaplatos redondo		Körper · block · corps · cuerpo:	PP
			Maße · size · mesure · medidas/mm:	255 x 65 x 50
			Besatzhöhe · bristle trim · taille garniture · altura cerda/mm:	23
			Besatzmaterial · bristle · matériel · material:	PBT Ø 0,35 
				0-140°C  HACCP  



1580



FC1581

FC1582

FC1583

FC1584

FC1585

FC1587

0540	Spülbürste eckig dishwashing-brush square brosse à vaisselle carrée cepillo para lavaplatos cuadrado		Körper · block · corps · cuerpo:	PP
			Maße · size · mesure · medidas/mm:	260 x 50 x 45
			Besatzhöhe · bristle trim · taille garniture · altura cerda/mm:	22
			Besatzmaterial · bristle · matériel · material:	Nyl 6.6 Ø 0,40 
				0-130°C  HACCP  

SPÜLBÜRSTEN UND KÜCHENHELFER · DISHWASHING-BRUSHES AND KITCHEN GADGETS · BROSSES À VAISSELLE ET UTENSILES DE CUISINE · CEPILLOS PARA LAVAPLATOS Y UTENSILIOS DE COCINA

1370		Körper · block · corps · cuerpo:	PP
		Maße · size · mesure · medidas/mm:	275 x 60 x 72
Spülbürste super super dishwashing-brush brosse à vaisselle superbe cepillo para lavaplatos genial		Besatzhöhe · bristle trim · taille garniture · altura cerda/mm:	20
		Besatzmaterial · bristle · matériel · material:	Nyl 6.6 Ø 0,40 
		0-130°C	 HACCP  

1380		Körper · block · corps · cuerpo:	PP
		Maße · size · mesure · medidas/mm:	270 x 65 x 50
Spülbürste oval dishwashing-brush oval brosse à vaisselle ovale cepillo para lavaplatos ovalada		Besatzhöhe · bristle trim · taille garniture · altura cerda/mm:	20
		Besatzmaterial · bristle · matériel · material:	Nyl 6.6 Ø 0,40 
		0-130°C	 HACCP  

1390		Körper · block · corps · cuerpo:	PP
		Maße · size · mesure · medidas/mm:	260 x 30 x 55
Spülbürste oval dishwashing-brush oval brosse à vaisselle ovale cepillo para lavaplatos ovalada		Besatzhöhe · bristle trim · taille garniture · altura cerda/mm:	20
		Besatzmaterial · bristle · matériel · material:	Nyl 6.6 Ø 0,40 
		0-130°C	 HACCP  

1430		Topffeger eckig potscourer square brosse à vaisselle carrée cepillo para lavaplatos cuadrado	
		Körper · block · corps · cuerpo:	PP
		Maße · size · mesure · medidas/mm:	260 x 50 x 45
		Besatzhöhe · bristle trim · taille garniture · altura cerda/mm:	20
		Besatzmaterial · bristle · matériel · material:	 Ø 0,18 mm Messingdraht · brass wire · fil de laiton · alambre de latón
		0-600°C	
		 HACCP 	

1440		Spülbürste schmal dishwashing-brush slim brosse à vaisselle étroite cepillo para lavaplatos estrecho	
		Körper · block · corps · cuerpo:	PP
		Maße · size · mesure · medidas/mm:	295 x 30 x 50
		Besatzhöhe · bristle trim · taille garniture · altura cerda/mm:	23
		Besatzmaterial · bristle · matériel · material:	Nyl 6.6 Ø 0,40 
		0-130°C	
		 HACCP  	



12894

Knopfbürste mit Spülmittelspender
 dishwashing-knob with liquid-soap-dispenser
 brosse à vaisselle avec dispensateur de savon liquide
 cepillo para lavaplatos con dispensador de jabón líquido



Körper · block · corps · cuerpo: PS
 Maße · size · mesure · medidas/mm: Ø 65 x 90
 Besatzhöhe · bristle trim · taille garniture · altura cerda/mm: 20
 Besatzmaterial · bristle · matériel · material: Nyl 6.6 Ø 0,40

10-130°C

HACCP



15090

Spülbürste mit Edelstahlgriff
 dishwashing-brush with stainless steel handle
 brosse à vaisselle avec manche en acier inox
 cepillo para lavaplatos con mango acero inox



Körper · block · corps · cuerpo: PP/INOX
 Maße · size · mesure · medidas/mm: 235 x 50 x 50
 Besatzhöhe · bristle trim · taille garniture · altura cerda/mm: 20
 Besatzmaterial · bristle · matériel · material: PBT Ø 0,35

-20-140°C



HACCP



15190

Spülbürste mit Edelstahlgriff
 dishwashing-brush with stainless steel handle
 brosse à vaisselle avec manche en acier inox
 cepillo para lavaplatos con mango acero inox



Körper · block · corps · cuerpo: PP/INOX
 Maße · size · mesure · medidas/mm: 240 x 60 x 60
 Besatzhöhe · bristle trim · taille garniture · altura cerda/mm: 20
 Besatzmaterial · bristle · matériel · material: PBT Ø 0,35

-20-140°C



HACCP



15390

Spülbürste mit Edelstahlgriff
 dishwashing-brush with stainless steel handle
 brosse à vaisselle avec manche en acier inox
 cepillo para lavaplatos con mango acero inox



Körper · block · corps · cuerpo: PP/INOX
 Maße · size · mesure · medidas/mm: 245 x 70 x 65
 Besatzhöhe · bristle trim · taille garniture · altura cerda/mm: 20
 Besatzmaterial · bristle · matériel · material: PBT Ø 0,35

-20-140°C



HACCP



15091/15191/15391

Ersatzköpfe für Edelstahl Spülbürsten
 recharge-heads for stainless steel dishwashing-brushes
 têtes de rechange pour brosse à vaisselle en acier inox
 repuestos cepillo para lavaplatos acero inox

Körper · block · corps · cuerpo: PP
 Maße · size · mesure · medidas/mm: 115 x 50 x 50 / 125 x 60 x 60 / 130 x 70 x 65
 Besatzhöhe · bristle trim · taille garniture · altura cerda/mm: 20
 Besatzmaterial · bristle · matériel · material: PBT Ø 0,35

-20-140°C



HACCP







15091

15191





15391

BÄCKERBÜRSTEN UND BESEN • BRUSHES AND BROOMS FOR BAKERY • BROSSES ET BALAIS POUR BOULANGERS • CEPILLOS Y ESCOBAS PARA PANADERÉAS

FC82001		Körper · block · corps · cuerpo:	PP
		Maße · size · mesure · medidas/mm:	420 x 60 x 70
Brotstreicher bread-brush brosse à dorer le pain cepillo panaderos		Besatzhöhe · bristle trim · taille garniture · altura cerda/mm:	58
		Besatzmaterial · bristle · matériel · material:	PBT Ø 0,25  ▲
		-20-140°C	 HACCP  

FC82002		Körper · block · corps · cuerpo:	PP
		Maße · size · mesure · medidas/mm:	420 x 60 x 70
Brotstreicher bread-brush brosse à dorer le pain cepillo panaderos		Besatzhöhe · bristle trim · taille garniture · altura cerda/mm:	58
		Besatzmaterial · bristle · matériel · material:	PBT Ø 0,25  ▲
		-20-140°C	 HACCP  



FC8200U		
	FC82001U	FC82002U
Brotstreicher bread-brush brosse à dorer le pain cepillo panaderos	Körper · block · corps · cuerpo:	
	Maße · size · mesure · medidas/mm:	
	Besatzhöhe · bristle trim · taille garniture · altura cerda/mm:	
	Besatzmaterial · bristle · matériel · material:	
		-20-140°C
		 HACCP  

FC82101		Körper · block · corps · cuerpo:	PP
		Maße · size · mesure · medidas/mm:	320 x 35 x 78
Mehlbesen flour-brush balayette à farine cepillo para harina		Besatzhöhe · bristle trim · taille garniture · altura cerda/mm:	55
		Besatzmaterial · bristle · matériel · material:	PBT Ø 0,25  ▲
		-20-140°C	 HACCP  

FC82102		Körper · block · corps · cuerpo:	PP
		Maße · size · mesure · medidas/mm:	320 x 35 x 78
Mehlbesen flour-brush balayette à farine cepillo para harina		Besatzhöhe · bristle trim · taille garniture · altura cerda/mm:	55
		Besatzmaterial · bristle · matériel · material:	PBT Ø 0,25  ▲
		-20-140°C	 HACCP  



FC8210U

Mehlbesen flour-brush balayette à farine cepillo para harina	 FC82101U	 FC82102U	 FC82103U
Körper · block · corps · cuerpo: PP			
Maße · size · mesure · medidas/mm: 320 x 35 x 78			
Besatzhöhe · bristle trim · taille garniture · altura cerda/mm: 55			
Besatzmaterial · bristle · matériel · material: PBT Ø 0,25			
-20-140°C			



8242

Backofenbesen oven-broom balai de four escoba para horno		
Körper · block · corps · cuerpo: PP		
Maße · size · mesure · medidas/mm: 260 x 100 x 100		
Besatzhöhe · bristle trim · taille garniture · altura cerda/mm: 65		
Besatzmaterial · bristle · matériel · material: Naturfibre · tampico · fibre naturel · fibra natural		
-20-180°C		

8242HT

Backofenbesen oven-broom balai de four escoba para horno		
Körper · block · corps · cuerpo: PP		
Maße · size · mesure · medidas/mm: 260 x 100 x 100		
Besatzhöhe · bristle trim · taille garniture · altura cerda/mm: 65		
Besatzmaterial · bristle · matériel · material: PEEK Ø 0,40		
-20-250°C		

8752

Backofenbesen oven-broom balai de four escoba para horno		
Körper · block · corps · cuerpo: PP		
Maße · size · mesure · medidas/mm: 320 x 75 x 115		
Besatzhöhe · bristle trim · taille garniture · altura cerda/mm: 70		
Besatzmaterial · bristle · matériel · material: Arenga		
-20-300°C		

8862

Backofenbesen oven-broom balai de four escoba para horno		
Körper · block · corps · cuerpo: PP		
Maße · size · mesure · medidas/mm: 430 x 110 x 140		
Besatzhöhe · bristle trim · taille garniture · altura cerda/mm: 65		
Besatzmaterial · bristle · matériel · material: Arenga		
-20-300°C		

BÄCKERBÜRSTEN UND BESEN • BRUSHES AND BROOMS FOR BAKERY • BROSSES ET BALAIS POUR BOULANGERS • CEPILLOS Y ESCOBAS PARA PANADERÉAS



8220

Backofenbürste
oven-brush
brosse de four
cepillo para horno



Körper · block · corps · cuerpo: PP
Maße · size · mesure · medidas/mm: 410 x 80 x 75
Besatzhöhe · bristle trim ·
taille garniture · altura cerda/mm: 60
Besatzmaterial · bristle · matériel · material:
Naturfibre · tampico · fibre naturel · fibra natural  |

-20-180°C



8220HT

Backofenbürste
oven-brush
brosse de four
cepillo para horno



Körper · block · corps · cuerpo: PP
Maße · size · mesure · medidas/mm: 410 x 80 x 75
Besatzhöhe · bristle trim ·
taille garniture · altura cerda/mm: 60
Besatzmaterial · bristle · matériel · material:
PEEK Ø 0,40  |

-20-250°C



HACCP



8290

Schneidmaschinenbürste
brush for cutting machines
brosse pour hachoirs
cepillo para máquinas de corte

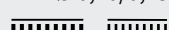

Körper · block · corps · cuerpo: PP
Maße · size · mesure · medidas/mm: 325 x 125 x 70
Ø/mm: 10/40
Besatzlänge · bristle length ·
longueur matériel · largo material/mm: 175
Besatzmaterial · bristle · matériel · material:
PBT Ø 0,20/0,25  | |

-20-140°C











HACCP



METZGERBÜRSTEN UND -ARTIKEL · BRUSHES AND TOOLS FOR BUTCHERS · BROSSES ET OUTILS POUR BOUCHERS · CEPILLOS Y HERRAMIENTAS PARA CARNICERÉAS







8740		Körper · block · corps · cuerpo:	PP
		Maße · size · mesure · medidas/mm:	Ø 120 x 135
Wolfbürste turk's head-brush brosse cylindrique pour hachoirs et cuves hisopo cilíndrico		Besatzhöhe · bristle trim · taille garniture · altura cerda/mm:	30
		Besatzmaterial · bristle · matériel · material:	PBT Ø 0,50 
		-20-140°C	  HACCP  
			
8740	FC87401	FC87402	FC87403
			
			
			
			FC87407

8760		Körper · block · corps · cuerpo:	PP
		Maße · size · mesure · medidas/mm:	200 x 125 x 105
Kesselbürste tank-brush brosse pour tanks cepillo para tanque		Besatzhöhe · bristle trim · taille garniture · altura cerda/mm:	35
		Besatzmaterial · bristle · matériel · material:	PBT Ø 0,50 
		-20-140°C	  HACCP  
			
8760	FC87601	FC87602	FC87603
			
			
			
			FC87607



87612		Körper · block · corps · cuerpo:	PP
		Maße · size · mesure · medidas/mm:	200 x 125 x 105
Kesselbürste tank-brush brosse pour tanks cepillo para tanque		Besatzhöhe · bristle trim · taille garniture · altura cerda/mm:	35
		Besatzmaterial · bristle · matériel · material:	PP Ø 0,25 
		-20-80°C	 HACCP 



8742		Körper · block · corps · cuerpo:	PP
		Maße · size · mesure · medidas/mm:	400 x Ø 90
Wolfbürste turk's head-brush brosse cylindrique pour hachoirs et cuves hisopo cilíndrico		Besatzhöhe · bristle trim · taille garniture · altura cerda/mm:	30
		Besatzmaterial · bristle · matériel · material:	PBT Ø 0,50 
		-20-140°C	 HACCP  

METZGERBÜRSTEN UND -ARTIKEL • BRUSHES AND TOOLS FOR BUTCHERS • BROSSES ET OUTILS POUR BOUCHERS • CEPILLOS Y HERRAMIENTAS PARA CARNICERÍAS



8755

Kutterbürste
cutter-brush
brosse pour hachoirs
cepillo para laminadoras



Körper · block · corps · cuerpo: PP
Maße · size · mesure · medidas/mm: 490 x 120 x 73
Besatzhöhe · bristle trim · taille garniture · altura cerda/mm: 45
Besatzmaterial · bristle · matériel · material: PBT Ø 0,50

-20-140°C HACCP 10

8756

Kutterbürste
cutter-brush
brosse pour hachoirs
cepillo para laminadoras



Körper · block · corps · cuerpo: PP
Maße · size · mesure · medidas/mm: 490 x 150 x 73
Besatzhöhe · bristle trim · taille garniture · altura cerda/mm: 45
Besatzmaterial · bristle · matériel · material: PBT Ø 0,50

-20-140°C HACCP 5

8729

Rührlöffel
paddle-scraper
raclette à cuves
paleta raspadora



Körper · block · corps · cuerpo: TPE
Maße · size · mesure · medidas/mm: 190 x 120 x 31
ohne Stiel · without handle · sans manche · sin mango

-20-121°C HACCP 10

8730

Rührlöffel
paddle-scraper
raclette à cuves
paleta raspadora



Körper · block · corps · cuerpo: PP
Maße · size · mesure · medidas/mm: 190 x 120 x 31
ohne Stiel · without handle · sans manche · sin mango

-20-80°C HACCP 10

8731

Rührlöffel
paddle-scraper
raclette à cuves
paleta raspadora



Körper · block · corps · cuerpo: PP
Maße · size · mesure · medidas/mm: 1205 x 138 x 30
einteilig mit Stiel · one piece with handle · une pièce avec manche · una pieza con mango

-20-80°C HACCP 1



88337

**Hobel für Kunststoff
Schneidebretter und Hobel**
plane for plastic chopping blocks
and boards
rabot pour billots
et planches en plastique
recuperador para tablas
de corte de plástico



Körper · block · corps · cuerpo: PA/INOX
Maße · size · mesure · medidas/mm: 160 x 60 x 90

Anwendung · use · usage · uso:
mit 2 Schneidseiten · with 2 cutting sides · avec 2 lames · 2 lados de corte
• für Schneidebretter Art. 8950+8951 · for cutting boards art. 8950+8951
• pour planches art. 8950+8951 · para tablas de cortar art. 8950+8951

-20-200°C



HACCP



88338

**Ersatzklinge
refill blade
recharge lame
hoja de repuesto**



Körper · block · corps · cuerpo: INOX
Maße · size · mesure · medidas/mm: 50 x 10 x 2

Anwendung · use · usage · uso:
mit 2 Schneidseiten für Art. 88337 · with 2 cutting sides for art. 88337
• avec 2 lames pour art. 88337 · 2 lados de corte para art. 88337

-20-600°C



HACCP



8834

**Hackstockbürste für Holz Hack-
stöcke und -platten**
brush for wooden chopping
blocks and boards
brosse pour billots
et planches en bois
raspador para tablas de corte de
madera



Körper · block · corps · cuerpo: PP
Maße · size · mesure · medidas/mm: 185 x 75 x 60

Besatzhöhe · bristle trim · taille garniture · altura cerda/mm: 37

Besatzmaterial · bristle · matériel · material: 
Flachdraht verzinkt · galvanized flat wire · fil de fer plat · alambre plano galvanizado - 3,3 x 0,6

-20-150°C



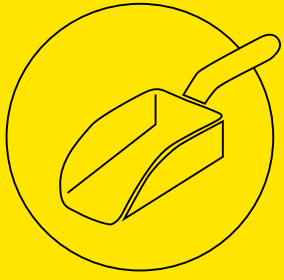

**KÜCHENHELFER
KITCHEN GADGETS
UTENSILES DE CUISINE
UTENSILIOS DE COCINA**



SPACHTELN + SCHABER • SPATULAS + SCRAPERS • SPATULES + RACLOIRS • ESPÁTULAS + RASPADORES



8929

Spachtel
spatula
spatule
espátula



Körper · block · corps · cuerpo: PA GF
Maße · size · mesure · medidas/mm: 250 x 110 x 18

-20-240°C



HACCP



8939

Handschaber
hand scraper
racloir à main
raspador de mano



Körper · block · corps · cuerpo: PP/INOX
Maße · size · mesure · medidas/mm: 209 x 270 x 5
Material · material · matériel · material:
INOX: Griff PP · handle PP · manche PP · mango PP

0-600°C



HACCP



8930

Schaber klein
scraper small
racloir petit
raspador pequeño

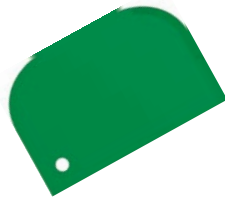

Körper · block · corps · cuerpo: PP
Maße · size · mesure · medidas/mm: 150 x 100 x 2
Anwendung · use · usage · uso:
flexibel · flexible · flexible · flexible

-20-80°C



HACCP



8930



89301



89302



89303



89304



89305



89307

8931

Schaber groß
scraper big
racloir grand
raspador grande



Körper · block · corps · cuerpo: PP
Maße · size · mesure · medidas/mm: 230 x 120 x 2
Anwendung · use · usage · uso:
flexibel · flexible · flexible · flexible

-20-80°C



HACCP



8931



89311



89312



89313



89314



89315



89317

8944

Teigabstecher
dough cutter
coupe-pâte
cortador de masa

*



Körper · block · corps · cuerpo: PP/INOX
Maße · size · mesure · medidas/mm: 125 x 100 x 5
Material · material · matériel · material:
INOX 18/10: Griff PP · handle PP · manche PP · mango PP
Anwendung · use · usage · uso:
flexibel · flexible · flexible · flexible

-20-600°C



HACCP



89440



89441



89442



89443



89444







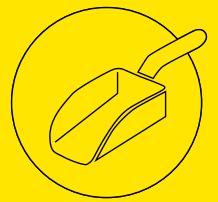





89447









HANDSCHAUFELN + SCHÖPFBEHÄLTER • SCOOPS • PELLES À MAIN + LOUCHES • PORUÑAS DE MANO



8922		Körper · block · corps · cuerpo: PP				
		Maße · size · mesure · medidas/mm: 328 x 136 x 79				
Handschaufel groß hand scoop big pelle à main grande poruña de mano grande		Anwendung · use · usage · uso: Fassungsvermögen 1,3l · capacity 1,3l · capacité 1,3l · capacidad 1,3l				
		-20-80°C  HACCP  				
 8922	 89221	 89222	 89223	 89224	 89225	 89227

8926		Körper · block · corps · cuerpo: PP				
		Maße · size · mesure · medidas/mm: 280 x 110 x 66				
Handschaufel klein hand scoop small pelle à main petite poruña de mano pequeña		Anwendung · use · usage · uso: Fassungsvermögen 0,7l · capacity 0,7l · capacité 0,7l · capacidad 0,7l				
		-20-80°C  HACCP  				
 8926	 89261	 89262	 89263	 89264	 89265	 89267

8947		Körper · block · corps · cuerpo: PP				
		Maße · size · mesure · medidas/mm: 360 x Ø 220 x 120				
Schöpfkelle bowl scoop louche poruña bowl		Anwendung · use · usage · uso: Fassungsvermögen 1,5l · capacity 1,5l · capacité 1,5l · capacidad 1,5l				
		-20-80°C  HACCP  				
 89470	 89471	 89472	 89473	 89474		

8948		Körper · block · corps · cuerpo: PP			
		Maße · size · mesure · medidas/mm: 175 x 240 x 150			
Messbecher pouring jug gobelet à mesurer vaso medidor		Anwendung · use · usage · uso: Fassungsvermögen 2l · capacity 2l · capacité 2l · capacidad 2l mit Messskala · with measuring scale · avec échelle de mesure · con escala de medición			
		-20-80°C  HACCP  			
 89480	 89481	 89482	 89483	 89484	



SCHNEIDEBRETTER + ZUBEHÖR • CUTTING BOARDS + ACCESSOIRES PLANCHES À DÉCOUPER + ACCESSOIRES • TABLAS DE CORTE + ACCESORIOS



8950

Schneidebrett mit Safrille
cutting board with groove
planche à découper avec rigole
tabla de corte con ranura



Körper · block · corps · cuerpo: PE
Maße · size · mesure · medidas/mm: 500 x 300 x 20
Anwendung · use · usage · uso:
mit Gummifüßchen · with rubber feet · avec pieds en caoutchouc ·
con topes de goman

-20-80°C



HACCP



89500



89501



89502



89503



89504



89505



89507

8951

Schneidebrett mit Safrille
cutting board with groove
planche à découper avec rigole
tabla de corte con ranura



Körper · block · corps · cuerpo: PE
Maße · size · mesure · medidas/mm: 600 x 400 x 20
Anwendung · use · usage · uso:
mit Gummifüßchen · with rubber feet · avec pieds en caoutchouc ·
con topes de goman

-20-80°C



HACCP



89510



89511



89512



89513



89514



89515



89517

88337

Hobel
plane
rabot
recuperador



Körper · block ·
corps · cuerpo: PA
Maße · size · mesure ·
medidas/mm: 160 x 60 x 90

Anwendung · use · usage · uso:
INOX: mit 2 Schneidseiten · with 2 cutting sides · avec 2
lames · 2 lados de corte · für Schneidebretter Art. 8950+8951 ·
for cutting boards art. 8950+8951 · pour planches art.
8950+8951 · para tablas de cortar art. 8950+8951

-20-600°C



HACCP



88338

Ersatzklinge
refill blade
recharge lame
hoja de repuesto



Körper · block ·
corps · cuerpo: INOX
Maße · size · mesure ·
medidas/mm: 50 x 10 x 2

Anwendung · use · usage · uso:
INOX: mit 2 Schneidseiten für Art. 88337 · with 2 cutting sides
for art. 88337 · avec 2 lames pour art. 88337 · 2 lados de corte
para art. 88337

-20-600°C



HACCP



SCHWÄMME • SPONGES • ÉPONGES • ESPONJAS

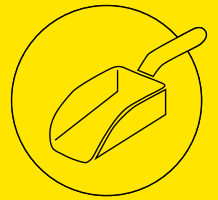

8620

Zelluloseschwamm
cellulose sponge
éponge cellulose
esponja celulosa



Maße · size · mesure · medidas/mm: 140 x 97 x 44

0-90°C  

512

Abrasivschwamm
abrasive sponge
éponge abrasive
esponja abrasivo



Körper · block · corps · cuerpo: PP
Maße · size · mesure · medidas/mm: 130 x 85 x 30
Anwendung · use · usage · uso: abrasiv · abrasive · abrasive · abrasivo

0-80°C  

5121 5122 5123 5124

8622

Schmutzradierer
erasers
gommes pour nettoyer la saleté
esponjas especial



Maße · size · mesure · medidas/mm: 138 x 50 x 30
Material · material · matériel · material: Melaminharz · melamine · mélamine · melamina
3 St. · 3 pcs · 3 pcs · 3 pzas



0-350°C  

8621

Abrasivschwamm
abrasive sponge
éponge abrasive
esponja abrasivo



Körper · block · corps · cuerpo: PP
Maße · size · mesure · medidas/mm: 160 x 100 x 40
Anwendung · use · usage · uso: abrasiv · abrasive · abrasive · abrasivo

0-80°C  

86211 86212 86213 86214

8626

Edelstahl-Topfreiniger
Stainless steel pads
pads inox
pads de inox



Maße · size · mesure · medidas/mm: Ø 70 x 60
Material · material · matériel · material: 40 g
5 St. · 5 pcs · 5 pcs · 5 pzas

0-600°C  HACCP  

8470

Microfasertuch
microfiber cloth
chiffon en microfibre
toalla de microfibra



Maße · size · mesure · medidas/mm: 320 x 320 x 2
Material · material · matériel · material: 80% PES, 20% PA - 300 g/m²
10 St. · 10 pcs · 10 pcs · 10 pzas

0-60°C   HACCP 

84701 84702 84703 84704

8927

Tellerabstreifer
plate- and sink-cleaner
nettoyeur pour assiettes et éviers
limpiador-raspador de platos



Körper · block · corps · cuerpo: PP
Maße · size · mesure · medidas/mm: 160 x 180 x 1

+10-80°C HACCP  





**FENSTERREINIGER
WINDOW CLEANERS
RACLETTES VITRES
LIMPIA-VENTANAS**

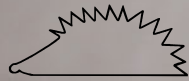

**ANWENDUNGSVIDEO
APPLICATION VIDEO
VIDÉO DE DÉMONSTRATION
VÉDEO DE APLICACIÓN**



074

Fenster- und Thekenwischer
window- and table wiper
raclette-vitres et de table
limpia-ventanas y mesa



Körper · block · corps · cuerpo:	PP
Maße · size · mesure · medidas/mm:	215 x 250 x 55
Arbeitsbreite · width · large · ancho/mm:	250
Material · material · matériel · material:	ZG

oder mit Stiel 07196 zu verwenden · or to be used with handle 07196 · ou à utiliser avec la manche 07196 · o para ser utilizado con el mango 07196

-20-75°C



HACCP



0740



0741



0742



0743



0744

0750

Fensterwischer
window-wiper
raclette-vitres
limpia-ventanas



Körper · block · corps · cuerpo:	PP
Maße · size · mesure · medidas/mm:	210 x 255 x 48
Arbeitsbreite · width · large · ancho/mm:	255

Material · material · matériel · material:
Aluleiste mit Gummilippe · alu border with rubber-lip · listel d'aluminium avec caoutchouc · riel alu con goma-labio

-20-70°C



0760

Fensterwischer
window-wiper
raclette-vitres
limpia-ventanas

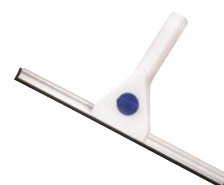

Körper · block · corps · cuerpo:	PP
Maße · size · mesure · medidas/mm:	210 x 350 x 48
Arbeitsbreite · width · large · ancho/mm:	350

Material · material · matériel · material:
Aluleiste mit Gummilippe · alu border with rubber-lip · listel d'aluminium avec caoutchouc · riel alu con goma-labio

-20-70°C



0770

Fensterreiniger
window-washer
raclette-vitres
limpia-ventanas



Körper · block · corps · cuerpo:	PP
Maße · size · mesure · medidas/mm:	195 x 260 x 85
Arbeitsbreite · width · large · ancho/mm:	260

Material · material · matériel · material:
Spezialschwamm + Gummilippe · special sponge + rubber-lip · éponge + caoutchouc · esponja especial + goma-labio

-20-60°C



0780

Hand-Wasserabzieher
hand squeegee
raclette à main
haragane de goma a mano



Körper · block · corps · cuerpo:	PP/MET
Maße · size · mesure · medidas/mm:	190 x 340 x 45
Arbeitsbreite · width · large · ancho/mm:	350

Material · material · matériel · material:
ZS

-20-60°C



084

Hand-Wasserabzieher mit
angespritzter Lippe
hand squeegee with
bi-injected lip
raclette à main avec
monolame élastomère
haragane de goma a mano
de labio bi-injectado



Körper · block · corps · cuerpo:	PP/TPE
Maße · size · mesure · medidas/mm:	225 x 300 x 40
Arbeitsbreite · width · large · ancho/mm:	300

Material · material · matériel · material:
abriebfest · abrasionproof · résistant à l'abrasion · resistente a la abrasión

-20-121°C



HACCP



0840



FC0841



FC0842



FC0843



FC0844

FENSTERREINIGER • WINDOW CLEANERS • RACLETTES VITRES • LIMPIA-VENTANAS



<p>540</p> <p>Glas- und Fliesenabzieher glass- and tiles wiper raclette-vitres limpia-ventanas</p>		<p>Körper • block • corps • cuerpo: PP/PVC Maße • size • mesure • medidas/mm: 165 x 200 x 7 Arbeitsbreite • width • large • ancho/mm: 200 Material • material • matériel • material: Gummilippe • rubber-lip • caoutchouc • goma-labiogoma-labio</p> <p>+5-70°C </p>
<p>543</p> <p>Hand-Wasserabzieher hand squeegee raclette à main haragone de goma a mano</p>		<p>Körper • block • corps • cuerpo: PP/TPE Maße • size • mesure • medidas/mm: 180 x 250 x 40 Arbeitsbreite • width • large • ancho/mm: 250 Material • material • matériel • material: TPE mit angespritzter Lippe • with bi-injected lip • avec monolame élastomère • con labio bi-injectado</p> <p>-20-80°C  HACCP  </p>
<p>8795</p> <p>Thekenreiniger counter cleaner raclette-comptoirs limpia-mostrador</p>		<p>Körper • block • corps • cuerpo: PP Maße • size • mesure • medidas/mm: 195 x 260 x 80 Arbeitsbreite • width • large • ancho/mm: 260 Material • material • matériel • material: ZG Gummilippe • rubber-lip • caoutchouc • goma-labiogoma-labio</p> <p>-20-80°C  </p>
<p>8477</p> <p>Jalousienreiniger blinds cleaner brosse de nettoyage pour stores limpia persianas</p>		<p>Maße • size • mesure • medidas/mm: 220 x 70 x 37 Arbeitsbreite • width • large • ancho/mm: 110 Material • material • matériel • material: PES</p> <p>0-95°C </p>
<p>84779</p> <p>Jalousienreiniger Ersatzbezug blinds cleaner recharge brosse de nettoyage pour stores remplacement limpia persianas sustitución</p>		<p>Maße • size • mesure • medidas/mm: 110 x 45 x 10 Material • material • matériel • material: PES</p> <p>0-95°C </p>
<p>8500</p> <p>Fensterwischer-Griff window-wiper handle poignée pour raclettes-vitres mango de limpia-ventanas</p>		<p>Körper • block • corps • cuerpo: PP/TPE/INOX Maße • size • mesure • medidas/mm: 150 x 93 x 35 Gewinde • thread • vissage • rosca-hilo: 8689 für Art. 8525, 8535, 8545, 8689 • for art. 8525, 8535, 8545, 8689 • pour art. 8525, 8535, 8545, 8689 • para art. 8525, 8535, 8545, 8689</p> <p>-20-80°C HACCP  </p>
<p>8525</p> <p>Fensterwischer-Schiene window-wiper blade barrette pour raclettes-vitres banda de limpia ventanas</p>		<p>Maße • size • mesure • medidas/mm: 20 x 250 x 5 Arbeitsbreite • width • large • ancho/mm: 250 Material • material • matériel • material: INOX mit Gummilippe, für Fensterwischergriff Art. 8500 • INOX with rubber-lip, for window-wiper handle art. 8500 • INOX avec caoutchouc, pour poignée art. 8500 • INOX con goma-labiogoma-labio, para mangos de limpia-ventanas art. 8500</p> <p>-20-70°C </p>

85259

Ersatzgummi für Art. 8525
refill rubber for art. 8525
caoutchouc remplacement art. 8525
goma sustitución para art. 8525



Maße · size · mesure · medidas/mm 20 x 250 x 5

Arbeitsbreite · width · large · ancho/mm: 250

Material · material · matériel · material:

Gummi für Fensterwischergriff · rubber for window-wiper handle · caoutchouc, pour poignée · goma para mangos de limpia-ventanas

-20-70°C



8535

Fensterwischer-Schiene
window-wiper blade
barrette pour raclette-vitre
banda de limpia ventana



Maße · size · mesure · medidas/mm 20 x 350 x 5

Arbeitsbreite · width · large · ancho/mm: 350

Material · material · matériel · material: INOX mit Gummilippe, für Fensterwischergriff Art. 8500 · INOX with rubber-lip, for window-wiper handle art. 8500 · INOX avec caoutchouc, pour poignée art. 8500 · INOX con goma-labiogoma-labio, para mangos de limpia-ventanas art. 8500

-20-70°C



85359

Ersatzgummi für Art. 8535
refill rubber for art. 8535
caoutchouc remplacement art. 8535
goma sustitución para art. 8535



Maße · size · mesure · medidas/mm 20 x 350 x 5

Arbeitsbreite · width · large · ancho/mm: 350

Material · material · matériel · material:

Gummi · rubber · caoutchouc · goma

-20-70°C



8545

Fensterwischer-Schiene
window-wiper blade
barrette pour raclette-vitre
banda de limpia ventana



Maße · size · mesure · medidas/mm 20 x 450 x 5

Arbeitsbreite · width · large · ancho/mm: 450

Material · material · matériel · material: INOX mit Gummilippe, für Fensterwischergriff Art. 8500 · INOX with rubber-lip, for window-wiper handle art. 8500 · INOX avec caoutchouc, pour poignée art. 8500 · INOX con goma-labiogoma-labio, para mangos de limpia-ventanas art. 8500

-20-70°C



85459

Ersatzgummi für Art. 8545
refill rubber for art. 8545
caoutchouc remplacement art. 8545
goma sustitución para art. 8545



Maße · size · mesure · medidas/mm 20 x 450 x 5

Arbeitsbreite · width · large · ancho/mm: 450

Material · material · matériel · material:

Gummi · rubber · caoutchouc · goma

-20-70°C



8550

T-Trägerteil
T-bar
support T
soporte T



Körper · block · corps · cuerpo:

PP

Maße · size · mesure · medidas/mm: 150 x 450 x 34

Arbeitsbreite · width · large · ancho/mm: 450

Gewinde · thread · vissage · rosca-hilo: 8689

für Art. 8551, 8552, 8689 · for art. 8551, 8552, 8689 ·

pour art. 8551, 8552, 8689 · para art. 8551, 8552, 8689

-20-80°C

HACCP



8551

Einwascherbezug
washer sleeve
housse pour le mouilleur
microfibra

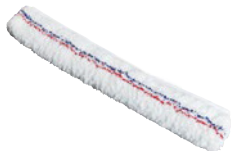

Maße · size · mesure · medidas/mm: 70 x 480 x 25

Arbeitsbreite · width · large · ancho/mm: 480

Material · material · matériel · material:

90% PA / 10% VS

für T-Trägerteil Art. 8550 · for T-bar art. 8550 ·

pour support T art. 8550 · para soporte T art. 8550

0-60°C



8552

Einwascherbezug
washer sleeve
housse pour le mouilleur
microfibra



Maße · size · mesure · medidas/mm: 70 x 480 x 25

Arbeitsbreite · width · large · ancho/mm: 480

Material · material · matériel · material:

90% PA / 10% VS

für T-Trägerteil Art. 8550 · for T-bar art. 8550 ·

pour support T art. 8550 · para soporte T art. 8550

0-60°C



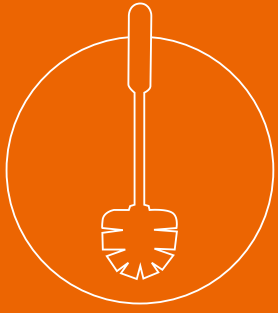

SANITÄR & WC
SANITARY & TOILET
SANITAIRE & WC
SANITARIO & WC





NAGELBÜRSTEN • NAIL-BRUSHES • BROSSES À ONGLES • ESCOBILLAS DE UÑAS

3150		Körper · block · corps · cuerpo:	PS
		Maße · size · mesure · medidas/mm:	110 x 50 x 32
Nagelbürste nail-brush brosse à ongles escobilla de uñas		Besatzhöhe · bristle trim · taille garniture · altura cerda/mm:	13/9
		Besatzmaterial · bristle · matériel · material:	Nyl 6.6 Ø 0,35 
		0-130°C	HACCP  



3170		Körper · block · corps · cuerpo:	PS
		Maße · size · mesure · medidas/mm:	110 x 50 x 32
Nagelbürste nail-brush brosse à ongles escobilla de uñas		Besatzhöhe · bristle trim · taille garniture · altura cerda/mm:	13/9
		Besatzmaterial · bristle · matériel · material:	PBT Ø 0,35 
		0-140°C	HACCP  



7120		Körper · block · corps · cuerpo:	PS
		Maße · size · mesure · medidas/mm:	90 x 30 x 50
Nagelbürste nail-brush brosse à ongles escobilla de uñas		Besatzhöhe · bristle trim · taille garniture · altura cerda/mm:	13
		Besatzmaterial · bristle · matériel · material:	Nyl 6.6 Ø 0,35 
		0-130°C	HACCP  



NAGELBÜRSTEN • NAIL-BRUSHES • BROSSES À ONGLES • ESCOBILLAS DE UÑAS

720		Körper • block • corps • cuerpo:	PS
		Maße • size • mesure • medidas/mm:	97 x 50 x 27
Nagelbürste nail-brush brosse à ongles escobilla de uñas		Besatzhöhe • bristle trim • taille garniture • altura cerda/mm:	13/10
		Besatzmaterial • bristle • matériel • material:	PBT Ø 0,35 
		0-140°C	HACCP  

740		Körper • block • corps • cuerpo:	PP
		Maße • size • mesure • medidas/mm:	108 x 42 x 32
Nagelbürste nail-brush brosse à ongles escobilla de uñas		Besatzhöhe • bristle trim • taille garniture • altura cerda/mm:	13/8
		Besatzmaterial • bristle • matériel • material:	PBT Ø 0,35 
		0-140°C	 HACCP  

3250		Körper • block • corps • cuerpo:	PS
		Maße • size • mesure • medidas/mm:	115 x 58 x 35
Nagelbürste mit Köcher nail-brush with suspension bracket brosse à ongles avec support escobilla de uñas con caja		Besatzhöhe • bristle trim • taille garniture • altura cerda/mm:	13/9
		Besatzmaterial • bristle • matériel • material:	Nyl 6.6 Ø 0,35 
		0-130°C	HACCP  

730		Körper • block • corps • cuerpo:	PS
		Maße • size • mesure • medidas/mm:	115 x 58 x 35
Nagelbürste mit Köcher nail-brush with suspension bracket brosse à ongles avec support escobilla de uñas con caja		Besatzhöhe • bristle trim • taille garniture • altura cerda/mm:	13/10
		Besatzmaterial • bristle • matériel • material:	PBT Ø 0,35 
		0-140°C	HACCP  

WC- UND SANITÄRBÜRSTEN • TOILET- AND SANITARY BRUSHES • BROSSES À WC ET SANITAIRES • CEPILLOS SANITARIOS Y PARA W.C.



6120

WC-Rundbürste
toilet-brush round
brosse à wc ronde
hisopo para w.c. redondo



Körper · block · corps · cuerpo: PP
Maße · size · mesure · medidas/mm: 400 x Ø 80
Besatzhöhe · bristle trim · taille garniture · altura cerda/mm: 25
Besatzmaterial · bristle · matériel · material: PP Ø 0,35

0-80°C HACCP



- WC-Bürsten auch in anderen Durchmessern produzierbar bzw. auch in anderen Sanitärfarben lieferbar
- Toilet-brushes producible also in other diameters as well available in other sanitary colours

- Brosses à wc à produire aussi en autres diamètres et livrables en autres couleurs sanitaires
- Los hisopos para w.c. pueden ser producidos en otros diámetros y están disponibles en otros colores sanitarios

61333

WC-Rundbürste
toilet-brush round
brosse à wc ronde
hisopo para w.c. redondo

Kopf auswechselbar
head changeable
tête interchangeable
cabezal intercambiable



Körper · block · corps · cuerpo: PP
Maße · size · mesure · medidas/mm: 370 x Ø 75
Besatzhöhe · bristle trim · taille garniture · altura cerda/mm: 25
Besatzmaterial · bristle · matériel · material: PP Ø 0,35
verchromter Metallgriff · chromed metal handle · mache métallique chromé · mango de metal cromado

0-80°C HACCP



613330

WC-Rundbürste
toilet-brush round
brosse à wc ronde
hisopo para w.c. redondo

Kopf auswechselbar
head changeable
tête interchangeable
cabezal intercambiable



Körper · block · corps · cuerpo: PP
Maße · size · mesure · medidas/mm: 370 x Ø 75
Besatzhöhe · bristle trim · taille garniture · altura cerda/mm: 25
Besatzmaterial · bristle · matériel · material: PP Ø 0,35
verchromter Metallgriff · chromed metal handle · mache métallique chromé · mango de metal cromado

0-80°C HACCP



6130

WC-Rundbürste
toilet-brush round
brosse à wc ronde
hisopo para w.c. redondo



613080

61388

6130

Körper · block · corps · cuerpo: PP
Maße · size · mesure · medidas/mm: 365 x Ø 75
Besatzhöhe · bristle trim · taille garniture · altura cerda/mm: 25
Besatzmaterial · bristle · matériel · material: PP Ø 0,35

0-80°C



61399

WC-Ersatzbürstenkopf rund
recharge-head for
toilet-brushes round
tête de rechange pour
brosses à wc rondes
repuesto para hisopos w.c.
redondo

Körper · block · corps · cuerpo: PP
Maße · size · mesure · medidas/mm: 215/180 x Ø 75
Besatzhöhe · bristle trim · taille garniture · altura cerda/mm: 25
Besatzmaterial · bristle · matériel · material: PP Ø 0,35

für · for · pour · para art. 61333

0-80°C HACCP

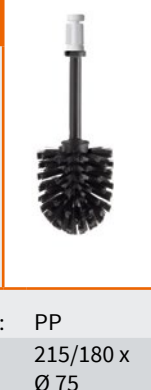

613990

WC-Ersatzbürstenkopf rund
recharge-head for
toilet-brushes round
tête de rechange pour
brosses à wc rondes
repuesto para hisopos w.c.
redondo

Körper · block · corps · cuerpo: PP
Maße · size · mesure · medidas/mm: 215/180 x Ø 75
Besatzhöhe · bristle trim · taille garniture · altura cerda/mm: 25
Besatzmaterial · bristle · matériel · material: PP Ø 0,35

für · for · pour · para art. 613330

0-80°C HACCP



WC- UND SANITÄRBÜRSTEN · TOILET- AND SANITARY BRUSHES · BROSSES À WC ET SANITAIRES · CEPILLOS SANITARIOS Y PARA W.C.

61390

WC-Rundbürste
toilet-brush round
brosse à wc ronde
hisopo para w.c. redondo

Kopf auswechselbar
head changeable
tête interchangeable
cabezal intercambiable



Körper · block · corps · cuerpo:	PP
Maße · size · mesure · medidas/mm:	345 x Ø 78
Besatzhöhe · bristle trim · taille garniture · altura cerda/mm:	26
Besatzmaterial · bristle · matériel · material:	PET Ø 0,40
Edelstahlgriff · stainless steel handle · mache en acier · mango en acero	

0-125°C HACCP 

613909

WC-Ersatzbürstenkopf rund
recharge-head for toilet-brushes round
tête de recharge pour brosses à wc rondes
repuesto para hisopos w.c. redondo



Körper · block · corps · cuerpo:	PP
Maße · size · mesure · medidas/mm:	95 x Ø 78
Besatzhöhe · bristle trim · taille garniture · altura cerda/mm:	26
Besatzmaterial · bristle · matériel · material:	PET Ø 0,40
für · for · pour · para art. 61390	

0-125°C HACCP 

6210

Urinflaschenbürste
urine-bottle-brush
brosse pour bouteilles d'urine
hisopo para botellas de urine



Körper · block · corps · cuerpo:	PP
Maße · size · mesure · medidas/mm:	390 x Ø 60
Besatzhöhe · bristle trim · taille garniture · altura cerda/mm:	17
Besatzmaterial · bristle · matériel · material:	PBT Ø 0,25

0-140°C  HACCP  

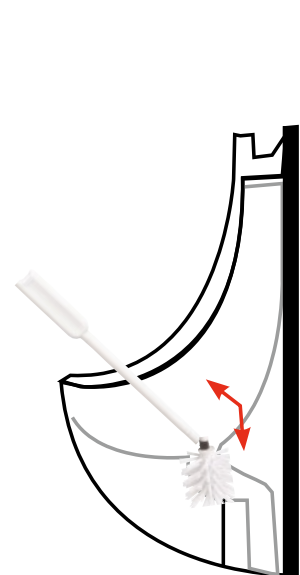



620

Urinalbürste
urinal-brush
brosse d'urinoir
hisopo de urinario

flexibler Bürstenkopf
flexible brush-head
tête de brosse flexible
hisopo-cabeza flexible
cabezal intercambiable



Körper · block · corps · cuerpo:	PP
Maße · size · mesure · medidas/mm:	355 x Ø 60
Besatzhöhe · bristle trim · taille garniture · altura cerda/mm:	26
Besatzmaterial · bristle · matériel · material:	PBT Ø 0,35
für Urinale · for urinals · pour urinoirs · para urinarios	

0-80°C HACCP  

6320

WC-Rundbürste
toilet-brush round
brosse à wc ronde
hisopo para w.c. redondo







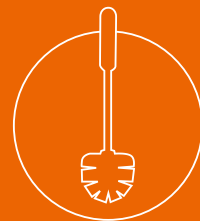

Körper · block · corps · cuerpo:	PP
Maße · size · mesure · medidas/mm:	365 x Ø 75
Besatzhöhe · bristle trim · taille garniture · altura cerda/mm:	25
Besatzmaterial · bristle · matériel · material:	PP Ø 0,35

0-80°C HACCP 



6330		Körper · block · corps · cuerpo:	PP
		Maße · size · mesure · medidas/mm:	365 x Ø 72
WC-Rundbürste toilet-brush round brosse à wc ronde hisopo para w.c. redondo		Besatzhöhe · bristle trim · taille garniture · altura cerda/mm:	25
		Besatzmaterial · bristle · matériel · material:	PP Ø 0,35 
		0-80°C	HACCP 

6350		WC-Rundbürste toilet-brush round brosse à wc ronde hisopo para w.c. redondo	
		Bürste gebogen brush curved brosse courbée hisopo curvado	
Körper · block · corps · cuerpo:	PP	Maße · size · mesure · medidas/mm:	
	395 x Ø 77		
Besatzhöhe · bristle trim · taille garniture · altura cerda/mm:	26	Besatzmaterial · bristle · matériel · material:	
	PP Ø 0,35 		
		0-80°C	HACCP 

6390		Behinderten WC-Rundbürste disabled toilet-brush round brosse ronde pour wcs pour handicapés hisopo para w.c. para discapitados	
Körper · block · corps · cuerpo:	PP	Maße · size · mesure · medidas/mm:	
	600 x Ø 72		
Besatzhöhe · bristle trim · taille garniture · altura cerda/mm:	25	Besatzmaterial · bristle · matériel · material:	
	PP Ø 0,35 		
		0-80°C	HACCP 



6420		Körper · block · corps · cuerpo:	PP
		Maße · size · mesure · medidas/mm:	380 x Ø 80
WC-Rundbürste toilet-brush round brosse à wc ronde hisopo para w.c. redondo		Besatzhöhe · bristle trim · taille garniture · altura cerda/mm:	25
		Besatzmaterial · bristle · matériel · material:	PP Ø 0,35 
		0-80°C	HACCP 





mit borstiger Kratzfläche
with bristles scraper
avec racloir en fibres
con cerdas para raspar

WC- UND SANITÄRBÜRSTEN · TOILET- AND SANITARY BRUSHES · BROSSES À WC ET SANITAIRES · CEPILLOS SANITARIOS Y PARA W.C.

6140

WC-Randreinigerbürste
loop-shaped toilet-brush
brosse à wc avec façon de coulant
hisopo w.c. forma especial





Körper · block · corps · cuerpo:	PP
Maße · size · mesure · medidas/mm:	400 x Ø 80
Besatzhöhe · bristle trim · taille garniture · altura cerda/mm:	25
Besatzmaterial · bristle · matériel · material:	PP Ø 0,35 

0-80°C HACCP  20

6150

WC-Randreinigerbürste
loop-shaped toilet-brush
brosse à wc avec façon de coulant
hisopo w.c. forma especial



Körper · block · corps · cuerpo:	PP
Maße · size · mesure · medidas/mm:	365 x Ø 75
Besatzhöhe · bristle trim · taille garniture · altura cerda/mm:	25
Besatzmaterial · bristle · matériel · material:	PP Ø 0,35 

0-80°C  20

6230

WC-Randreinigerbürste
loop-shaped toilet-brush
brosse à wc avec façon de coulant
hisopo w.c. forma especial



Körper · block · corps · cuerpo:	PP
Maße · size · mesure · medidas/mm:	425 x 80 x 120
Besatzmaterial · bristle · matériel · material:	Nyl. 6.0 Ø 0,35 

0-100°C  10



6240

WC-Randreinigerbürste
loop-shaped toilet-brush
brosse à wc avec façon de coulant
hisopo w.c. forma especial

mit Jumbo-Randreiniger
with jumbo loop-shape cleaner
avec jumbo brosse
limpiador con forma especial



Körper · block · corps · cuerpo:	PP
Maße · size · mesure · medidas/mm:	365 x Ø 75
Besatzhöhe · bristle trim · taille garniture · altura cerda/mm:	25
Besatzmaterial · bristle · matériel · material:	PP Ø 0,35 

0-80°C  10

6340

WC-Randreinigerbürste
loop-shaped toilet-brush
brosse à wc avec façon de coulant
hisopo w.c. forma especial



Körper · block · corps · cuerpo:	PP
Maße · size · mesure · medidas/mm:	365 x Ø 75
Besatzhöhe · bristle trim · taille garniture · altura cerda/mm:	25
Besatzmaterial · bristle · matériel · material:	PP Ø 0,35 

0-80°C  10

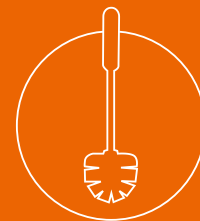

616

WC-Bürste mit Flüssigkeitsspender
 toilet-brush with liquid-soap-dispenser
 brosse à wc avec dispensateur de savon liquide
 hisopo w.c. con dispensador de jabón líquido



Körper · block · corps · cuerpo: PP
 Maße · size · mesure · medidas/mm: 350 x 110 x Ø 50
 Besatzmaterial · bristle · matériel · material: Nyl 6.0 Ø 0,35



0-100°C



617

Urinalbürste mit Flüssigkeitsspender
 urinal-brush with liquid-soap-dispenser
 brosse d'urinoir avec dispensateur de savon liquide
 hisopo de urinario con dispensador de jabón líquido



Körper · block · corps · cuerpo: PP
 Maße · size · mesure · medidas/mm: 400 x 80 x Ø 50
 Besatzmaterial · bristle · matériel · material: Nyl 6.0 Ø 0,35



0-100°C



1120

Waschbecken-überlaufbürste
 special cleaning brush for overflow-drain
 brosse spéciale pour nettoyer des trop-pleins
 cepillo de limpieza especial para lavamanos



Körper · block · corps · cuerpo: PP
 Maße · size · mesure · medidas/mm: 145 x 50/35 x Ø 25
 Besatzmaterial · bristle · matériel · material: reine Borste · pure bristle · soie pure · cerda pura



0-150°C



5110

Ausguß-Sauger mit Kunststoffstiel
 sink-plunger with plastic handle
 aspirateurs d'écoulement
 destapador w.c. con mango plástico



Körper · block · corps · cuerpo: PP
 Maße · size · mesure · medidas/mm: 515 x Ø 140

Besatzmaterial · bristle · matériel · material: Gummi · rubber · caoutchouc · goma

0-70°C



WC-GARNITUREN • TOILET-SETS • ENSEMBLES WC • SETS PARA W.C.

6260

WC-Garnitur
toilet-set
ensemble wc
set para w.c.



Körper · block · corps · cuerpo: PP
Maße · size · mesure · medidas/mm: 190 x 110 x 375
Form · shape · forme · diseño: modern · modern · moderne · moderno
Bürste · brush · brosse · hisopo: 6420

0-80°C HACCP 

6300

WC-Garnitur
toilet-set
ensemble wc
set para w.c.



Körper · block · corps · cuerpo: PP
Maße · size · mesure · medidas/mm: 120 x 110 x 425
Form · shape · forme · diseño: Schild · shield · écu · escudo
Bürste · brush · brosse · hisopo: 6350

0-80°C HACCP 

6360

WC-Garnitur
toilet-set
ensemble wc
set para w.c.



Körper · block · corps · cuerpo: PP
Maße · size · mesure · medidas/mm: 170 x 135 x 370
Form · shape · forme · diseño: Ecke · corner · coin · esquina
Bürste · brush · brosse · hisopo: 6330

0-80°C HACCP 

6370

WC-Garnitur
toilet-set
ensemble wc
set para w.c.



Körper · block · corps · cuerpo: PP
Maße · size · mesure · medidas/mm: 135 x 170 x 590
Form · shape · forme · diseño: Ecke · corner · coin · esquina
Bürste · brush · brosse · hisopo: 6390

0-80°C HACCP 

6540

WC-Garnitur
toilet-set
ensemble wc
set para w.c.



Körper · block · corps · cuerpo: PS
Maße · size · mesure · medidas/mm: Ø 145 x 410
Form · shape · forme · diseño: rund · round · rond · redondo
Bürste · brush · brosse · hisopo: 6140

0-80°C HACCP 

6550

WC-Garnitur
toilet-set
ensemble wc
set para w.c.



Körper · block · corps · cuerpo: PP
Maße · size · mesure · medidas/mm: Ø 143 x 375
Form · shape · forme · diseño: rund · round · rond · redondo
Bürste · brush · brosse · hisopo: 6130

0-80°C HACCP 

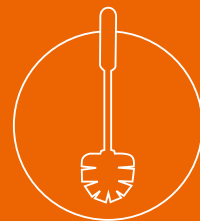

6580 WC-Garnitur toilet-set ensemble wc set para w.c.		Körper · block · corps · cuerpo: PP	Maße · size · mesure · medidas/mm: 165 x 130 x 405
		Form · shape · forme · diseño: Topf · caddy · pot · pote	Bürste · brush · brosse · hisopo: 6340
		0-80°C	

6590 WC-Garnitur toilet-set ensemble wc set para w.c.		Körper · block · corps · cuerpo: PP	Maße · size · mesure · medidas/mm: Ø 132 x 375
		Form · shape · forme · diseño: Topf · caddy · pot · pote	Bürste · brush · brosse · hisopo: 6130
		0-80°C	

65988 WC-Garnitur toilet-set ensemble wc set para w.c.		Körper · block · corps · cuerpo: PP	Maße · size · mesure · medidas/mm: Ø 132 x 375
		Form · shape · forme · diseño: Topf · caddy · pot · pote	Bürste · brush · brosse · hisopo: 61388
		0-80°C	



WC-GARNITUREN • TOILET-SETS • ENSEMBLES WC • SETS PARA W.C.

66090

WC-Garnitur
Edelstahl
toilet-set
stainless steel
ensemble wc
acier inox
set para w.c.
acero inox



Körper · block · corps · cuerpo: INOX
Maße · size · mesure · medidas/mm: Ø 90 x 370
Form · shape · forme · diseño: Topf · caddy · pot · pote
Bürste · brush · brosse · hisopo: 61390

0-130°C HACCP 

6610

WC-Garnitur
toilet-set
ensemble wc
set para w.c.



Körper · block · corps · cuerpo: PP
Maße · size · mesure · medidas/mm: 145 x 145 x 375
Form · shape · forme · diseño: eckig · square · carré · cuadrado
Bürste · brush · brosse · hisopo: 6130

0-80°C 

6640

WC-Garnitur
toilet-set
ensemble wc
set para w.c.



Körper · block · corps · cuerpo: PS
Maße · size · mesure · medidas/mm: 145 x 145 x 410
Form · shape · forme · diseño: eckig · square · carré · cuadrado
Bürste · brush · brosse · hisopo: 6140

0-80°C HACCP 

66990

WC-Garnitur
Edelstahl
toilet-set
stainless steel
ensemble wc
acier inox
set para w.c.
acero inox



Körper · block · corps · cuerpo: INOX
Maße · size · mesure · medidas/mm: 145 x Ø 90 x 365
Form · shape · forme · diseño: Wand · wall · mur · pared
Bürste · brush · brosse · hisopo: 61390

0-130°C HACCP 

6700

WC-Wandgarnitur
toilet-wall-set
ensemble wc mural
set para w.c. pared



Körper · block · corps · cuerpo: PP
Maße · size · mesure · medidas/mm: 115 x 100 x 410
Form · shape · forme · diseño: Wand · wall · mur · pared
Bürste · brush · brosse · hisopo: 6130

0-80°C 

67033

WC-Wandgarnitur
toilet-wall-set
ensemble wc mural
set para w.c. pared

verchromt
chromed
chromé
cromado



Körper · block · corps · cuerpo: PP
Maße · size · mesure · medidas/mm: 115 x 100 x 410
Form · shape · forme · diseño: Wand · wall · mur · pared
Bürste · brush · brosse · hisopo: 61333

0-80°C HACCP 



• WC-Garnituren auch in anderen Sanitärfarben lieferbar

• Toilet-sets also available in other sanitary colours

• Ensembles wc aussi livrables en autres couleurs sanitaires

• Los sets para w.c. también están disponibles en otros colores sanitarios



67088

Wandgarnitur
toilet-wall-set
ensemble wc mural
set para w.c. pared



Körper · block · corps · cuerpo: PP

Maße · size · mesure · medidas/mm: 115 x 100 x 410

Form · shape · forme · diseño: Wand · wall · mur · pared

Bürste · brush · brosse · hisopo: 61388

0-80°C



6840

WC-Garnitur
toilet-set
ensemble wc
set para w.c.



Körper · block · corps · cuerpo: PS

Maße · size · mesure · medidas/mm: Ø 180 x 410

Form · shape · forme · diseño: „Zwiebel“

Bürste · brush · brosse · hisopo: 6140

0-80°C

HACCP





**SPEZIAL-SORTIMENTE
SPECIAL ASSORTMENTS
GAMMES SPÉCIALES
PRODUCTOS ESPECIALES**





“IN-UP”

für professionelle Facility-Einsatzbereiche
for professional facility applications
pour les domaines d'application des installations
professionnelles para la gestión profesional de instalaciones



RECYCLED. FOR NATURE.

RECYCLED Produkte
RECYCLED products
RECYCLED produits
RECYCLED productos



METAL DETECT & X-RAY

detektierbare & röntgensichtbare Produkte
detectable & x-ray visible products
matériel détectable & radiographic visible produits
equipamiento detectable & rayos x visibles



ANTI-BAC

Produkte mit antibakteriellem Schutz
products with antibacterial protection
produits avec protection antibacterielle
productos con protección antibacteriana



ESD

antistatische Produkte
antistatic products
produits antistatiques
productos antiestáticos



"IN-UP" FÜR PROFESSIONELLE FACILITY-EINSATZBEREICHE • FOR PROFESSIONAL FACILITY APPLICATIONS • POUR LES DOMAINES D'APPLICATION DES INSTALLATIONS PROFESSIONNELLES • PARA LA GESTIÓN PROFESIONAL DE INSTALACIONES

975		Körper · block · corps · cuerpo:	PP
		Maße · size · mesure · medidas/mm:	330 x 100 x 100
"in-up" Besen "in-up" broom "in-up" balai "in-up" escoba		Besatzhöhe · bristle trim · taille garniture · altura cerda/mm:	57
		Besatzmaterial · bristle · matériel · material:	PET Ø 0,20 
		-20-130°C	 

976		Körper · block · corps · cuerpo:	PP
		Maße · size · mesure · medidas/mm:	330 x 85 x 100
"in-up" Besen "in-up" broom "in-up" balai "in-up" escoba		Besatzhöhe · bristle trim · taille garniture · altura cerda/mm:	57
		Besatzmaterial · bristle · matériel · material:	RH / PM 70/30 
		-20-80°C	 

984		"in-up" Großraumbesen "in-up" great-room-broom "in-up" balai pour grands espaces "in-up" escobillon para grandes espacios
Körper · block · corps · cuerpo:	PP	
Maße · size · mesure · medidas/mm:	630 x 110 x 100	
Besatzhöhe · bristle trim · taille garniture · altura cerda/mm:	60	
Besatzmaterial · bristle · matériel · material:	RH / PM 70/30 	
		-20-80°C  

986		"in-up" Großraumbesen "in-up" great-room-broom "in-up" balai pour grands espaces "in-up" escobillon para grandes espacios
Körper · block · corps · cuerpo:	PP	
Maße · size · mesure · medidas/mm:	630 x 120 x 120	
Besatzhöhe · bristle trim · taille garniture · altura cerda/mm:	70	
Besatzmaterial · bristle · matériel · material:	PET Ø 0,60 	
		-20-130°C  

987		"in-up" Hof- und Garagenbesen "in-up" outdoor broom "in-up" balai d'extérieur "in-up" escoba al aire libre
Körper · block · corps · cuerpo:	PP	
Maße · size · mesure · medidas/mm:	330 x 130 x 150	
Besatzhöhe · bristle trim · taille garniture · altura cerda/mm:	65	
Besatzmaterial · bristle · matériel · material:	PP Ø 0,60 	
		-20-130°C  



988

"in-up" Großraumbesen
 "in-up" great-room-broom
 "in-up" balai pour grands espaces
 "in-up" escobillon para grandes espacios



Körper · block · corps · cuerpo:	PP
Maße · size · mesure · medidas/mm:	410 x 110 x 140
Besatzhöhe · bristle trim · taille garniture · altura cerda/mm:	65
Besatzmaterial · bristle · matériel · material:	PET Ø 0,60 

-20-130°C  

990

"in-up" Großraumbesen
 "in-up" great-room-broom
 "in-up" balai pour grands espaces
 "in-up" escobillon para grandes espacios





Körper · block · corps · cuerpo:	PP
Maße · size · mesure · medidas/mm:	420 x 110 x 140
Besatzhöhe · bristle trim · taille garniture · altura cerda/mm:	75
Besatzmaterial · bristle · matériel · material:	PM Ø 0,27 



-20-80°C  

991

"in-up" Großraumbesen
 "in-up" great-room-broom
 "in-up" balai pour grands espaces
 "in-up" escobillon para grandes espacios



Körper · block · corps · cuerpo:	PP
Maße · size · mesure · medidas/mm:	410 x 100 x 95
Besatzhöhe · bristle trim · taille garniture · altura cerda/mm:	60
Besatzmaterial · bristle · matériel · material:	RH / PM 70/30 

-20-80°C  

992

"in-up" Großraumbesen
 "in-up" great-room-broom
 "in-up" balai pour grands espaces
 "in-up" escobillon para grandes espacios



Körper · block · corps · cuerpo:	PP
Maße · size · mesure · medidas/mm:	425 x 120 x 140
Besatzhöhe · bristle trim · taille garniture · altura cerda/mm:	65
Besatzmaterial · bristle · matériel · material:	PET Ø 0,80/0,60 

-20-130°C  

981

"in-up" Wischer
 "in-up" wiper
 "in-up" frottoir
 "in-up" cepillo para fregar



Körper · block · corps · cuerpo:	PP
Maße · size · mesure · medidas/mm:	280 x 60 x 80
Besatzhöhe · bristle trim · taille garniture · altura cerda/mm:	25
Besatzmaterial · bristle · matériel · material:	PP Ø 0,35 

-20-80°C  HACCP 

"IN-UP" FÜR PROFESSIONELLE FACILITY-EINSATZBEREICHE • FOR PROFESSIONAL FACILITY APPLICATIONS • POUR LES DOMAINES D'APPLICATION DES INSTALLATIONS PROFESSIONNELLES • PARA LA GESTIÓN PROFESIONAL DE INSTALACIONES

985

"in-up" Schrubber
 "in-up" scrub
 "in-up" frottoir
 "in-up" cepillo para fregar



Körper · block · corps · cuerpo:	PP
Maße · size · mesure · medidas/mm:	230 x 70 x 90
Besatzhöhe · bristle trim · taille garniture · altura cerda/mm:	25
Besatzmaterial · bristle · matériel · material:	PP Ø 0,35

-20-80°C



HACCP



989

"in-up" Großraumwischer
 "in-up" great-room-wiper
 "in-up" balais-brosse pour
 grands espaces
 "in-up" cepillo para
 fregar grandes espacios



Körper · block · corps · cuerpo:	PP
Maße · size · mesure · medidas/mm:	400 x 70 x 75
Besatzhöhe · bristle trim · taille garniture · altura cerda/mm:	25
Besatzmaterial · bristle · matériel · material:	PP Ø 0,35

-20-80°C



HACCP



979

"in-up" Wasserschieber
 zweilippig
 "in-up" rubber squeegee
 double bladed
 "in-up" raclette sol bilame
 "in-up" haragane de goma doble



Körper · block · corps · cuerpo:	PP
Maße · size · mesure · medidas/mm:	420 x 35 x 80
Besatzhöhe · rubber trim · taille garniture · altura goma/mm:	30
Besatzmaterial · rubber quality · matériel · material:	ZS

-20-60°C



980

"in-up" Wasserschieber
 zweilippig
 "in-up" rubber squeegee
 double bladed
 "in-up" raclette sol bilame
 "in-up" haragane de goma doble



Körper · block · corps · cuerpo:	PP
Maße · size · mesure · medidas/mm:	620 x 35 x 110
Besatzhöhe · rubber trim · taille garniture · altura goma/mm:	30
Besatzmaterial · rubber quality · matériel · material:	ZS

-20-60°C



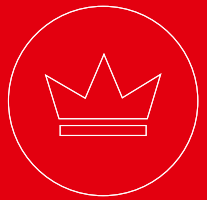

36002

Kehrgarnitur
dustpan-set
pelle et balayette
set de pala + cepillo



Körper · block · corps · cuerpo:	PP
Maße · size · mesure · medidas/mm:	350 x 235 x 100
Besatzhöhe · bristle trim · taille garniture · altura cerda/mm:	47
Besatzmaterial · bristle · matériel · material:	PET Ø 0,20



-20-130°C



19920

Kehrgarnitur mit
langem Stahlstiel
lobby dustpan-set
with long metal handle
pelle et balayette avec
manche long en métal
set de pala basculante +
escoba con mango largo
de metal



Körper · block · corps · cuerpo:	PP
Maße · size · mesure · medidas/mm:	80 x 250 x 1080
Besatzhöhe · bristle trim · taille garniture · altura cerda/mm:	60
Besatzmaterial · bristle · matériel · material:	PET Ø 0,60

-20-130°C



971

"in-up" Stahlstiel
"in-up" metal handle
"in-up" manche métallique
"in-up" mango de metal



Maße · size · mesure · medidas/mm:	1300 x Ø 42
Außen-Ø · Ø ext./mm:	21
Wandstärke · thickness · paroi · espesor/mm:	0,37
Material · material · matériel · material:	FE

0-80°C



972

"in-up" Aluminiumstiel
"in-up" aluminium handle
"in-up" manche aluminium
"in-up" mango de aluminio



Maße · size · mesure · medidas/mm:	1420 x Ø 42
Außen-Ø · Ø ext./mm:	22
Wandstärke · thickness · paroi · espesor/mm:	1,0
Material · material · matériel · material:	ALU

-20-100°C



973

"in-up" Stahlstiel 3-teilig
"in-up" metal handle 3 pcs.
"in-up" manche métallique 3 pcs.
"in-up" mango de metal 3 pzas.

Maße · size · mesure · medidas/mm:	130 x Ø 42
Außen-Ø · Ø ext./mm:	21
Wandstärke · thickness · paroi · espesor/mm:	0,32
Material · material · matériel · material:	FE

3-teilig · 3 pieces · 3 pièces · de 3 partes

0-80°C





RECYCLED. FOR NATURE.

RECYCLED PRODUKTE · RECYCLED PRODUCTS · RECYCLED PRODUCTS · RECYCLED PRODUCTOS

13740RC		mind./min. 94,3% RC	Körper · block · corps · cuerpo:	PP RC
		Spülbürste dishwashing-brush brosse à vaisselle cepillo para lavaplatos	Maße · size · mesure · medidas/mm:	275 x 60 x 72
			Besatzhöhe · bristle trim · taille garniture · altura cerda/mm:	20
			Besatzmaterial · bristle · matériel · material:	PET RC Ø 0,40 
			0-125°C 	

13840RC		mind./min. 93,6% RC	Körper · block · corps · cuerpo:	PP RC
		Spülbürste oval dishwashing-brush oval brosse à vaisselle ovale cepillo para lavaplato oval	Maße · size · mesure · medidas/mm:	270 x 65 x 50
			Besatzhöhe · bristle trim · taille garniture · altura cerda/mm:	20
			Besatzmaterial · bristle · matériel · material:	PET RC Ø 0,40 
			0-125°C 	

19940RC		mind./min. 97% RC	Kehrgarnitur mit langem Stahlstiel lobby dustpan-set with long metal handle pelle et balayette avec manche long en métal set de pala basculante + escoba con mango largo de metal
			Körper · block · corps · cuerpo: PP RC + FE Maße · size · mesure · medidas/mm: 85 x 250 x 1080 Besatzhöhe · bristle trim · taille garniture · altura cerda/mm: 60 Besatzmaterial · bristle · matériel · material: PET RC Ø 0,20 
-20-110°C 			

33840RC		mind./min. 94,9% RC	Spülbürste dishwashing-brush brosse à vaisselle cepillo para lavaplatos
		Körper · block · corps · cuerpo: PP RC Maße · size · mesure · medidas/mm: 265 x 50 x 85 Besatzhöhe · bristle trim · taille garniture · altura cerda/mm: 23 Besatzmaterial · bristle · matériel · material: PET RC Ø 0,40 	
0-125°C 			

58040RC		mind./min. 96% RC	Scheuerbürste scrubbing-brush brosse à main cepillo de mano para fregar
		Körper · block · corps · cuerpo: PP RC Maße · size · mesure · medidas/mm: 185 x 45 x 40 Besatzhöhe · bristle trim · taille garniture · altura cerda/mm: 26 Besatzmaterial · bristle · matériel · material: PET RC Ø 0,40 	
0-125°C 			

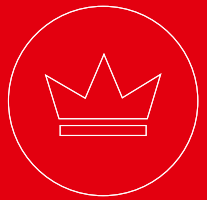

36040RC

mind./min. 94% RC

Kehrgarnitur rund
dustpan-set round
pelle et balayette ronde
set de pala + cepillo redondo



Körper · block · corps · cuerpo:	PP RC
Maße · size · mesure · medidas/mm:	350 x 235 x 100
Besatzhöhe · bristle trim · taille garniture · altura cerda/mm:	47
Besatzmaterial · bristle · matériel · material:	PET RC Ø 0,20

-20-110°C 

56040RC

mind./min. 91,8% RC

Kehrgarnitur rund
dustpan-set round
pelle et balayette ronde
set de pala + cepillo redondo



Körper · block · corps · cuerpo:	PP RC
Maße · size · mesure · medidas/mm:	320 x 230 x 90
Besatzhöhe · bristle trim · taille garniture · altura cerda/mm:	50
Besatzmaterial · bristle · matériel · material:	PET RC Ø 0,20

-20-110°C 

61380RC1

mind./min. 94,8% RC

WC-Rundbürste rund
toilet-brush round
brosse à wc ronde
hisopo para w.c. redondo



Körper · block · corps · cuerpo:	PP RC
Maße · size · mesure · medidas/mm:	365 x Ø 75
Besatzhöhe · bristle trim · taille garniture · altura cerda/mm:	25
Besatzmaterial · bristle · matériel · material:	PET RC Ø 0,40

0-125°C 

65340RC

mind./min. 97% RC

WC-Garnitur rund
toilet-set round
brosse à wc ronde
set pata w.c. redondo



Körper · block · corps · cuerpo:	PP RC
Maße · size · mesure · medidas/mm:	375 x Ø 116
Besatzhöhe · bristle trim · taille garniture · altura cerda/mm:	25
Besatzmaterial · bristle · matériel · material:	PET RC Ø 0,40

0-125°C 

Körper aus recycelten post-consumer Kunststoffabfällen (PCR) aus gelbem Sack/Tonne und Plastikmüll aus dem Meer 

blocks made of recycled post-consumer plastic waste (PCR) from yellow sack/bin and ocean plastic waste

corps fabriqué à partir de déchets plastiques post-consommation (PCR) issus des sacs/bacs jaunes et de déchets plastiques provenant de la mer

cuerpo fabricado con residuos plásticos posconsumo (PCR) reciclados procedentes de la bolsa/contenedor amarillo y de residuos plásticos marinos

Besatz aus recycelten post-industrial Kunststoffabfällen (PIR)

bristles made of recycled post-industrial plastic waste (PIR)

rembourrage en déchets plastiques post-industriels recyclés (PIR)

relleno de residuos plásticos postindustriales reciclados (PIR)

60% **CO₂** Einsparung durch Einsatz von Recyclaten
CO₂ savings through the use of recyclates
réduction des émissions de **CO₂** grâce à l'utilisation de matériaux recyclés
reducción de las emisiones de **CO₂** gracias al uso de materiales reciclados

100% **recyclebar · recyclable · recyclable · recyclable**

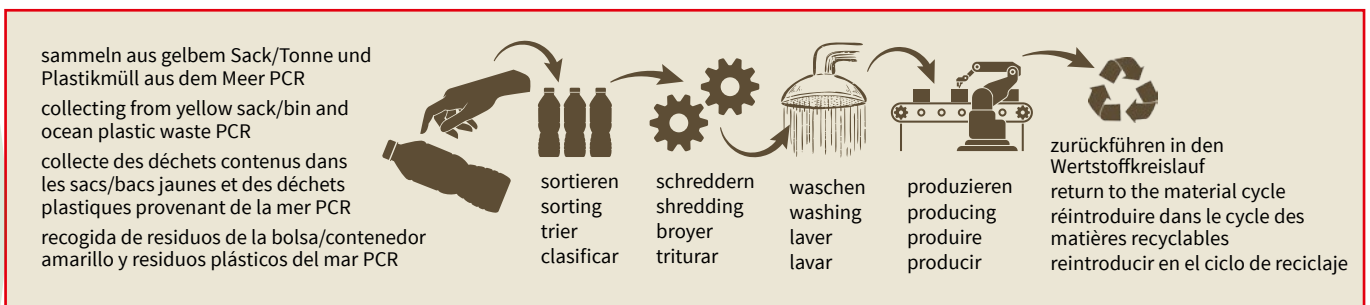







RECYCLED. FOR NATURE.

RECYCLED PRODUKTE · RECYCLED PRODUCTS · RECYCLED PRODUITS · RECYCLEDPRODUCTOS

839240RC	mind./min. 91,8% RC	
Fugenbürste joint-brush brosse joints cepillo articulado		
Körper · block · corps · cuerpo:	PP RC	
Maße · size · mesure · medidas/mm:	220 x 15 x 45	
Besatzhöhe · bristle trim · taille garniture · altura cerda/mm:	19	
Besatzmaterial · bristle · matériel · material:	PET RC Ø 0,40	
-20-125°C 		

882040RC	mind./min. 96,4% RC	
Stielbürste mit kurzem Griff churn-brush with short handle brosse à manche court cepillo mango corto		
Körper · block · corps · cuerpo:	PP RC	
Maße · size · mesure · medidas/mm:	260 x 72 x 70	
Besatzhöhe · bristle trim · taille garniture · altura cerda/mm:	35	
Besatzmaterial · bristle · matériel · material:	PET RC Ø 0,40	
-20-125°C 		

97940RC	mind./min. 80,4% RC		Körper · block · corps · cuerpo:	PP RC
"in-up" Wasserschieber "in-up" rubber squeegee "in-up" raclette sol "in-up" haragane			Maße · size · mesure · medidas/mm:	420 x 35 x 80
			Besatzhöhe · rubber trim · taille garniture · altura goma/mm:	30
			Besatzmaterial · rubber quality · matériel · material:	ZS
-20-60°C  				

98140RC	mind./min. 96,6% RC		Körper · block · corps · cuerpo:	PP RC
"in-up" Wischer "in-up" wiper "in-up" frottoir "in-up" cepillo para fregar			Maße · size · mesure · medidas/mm:	280 x 60 x 80
			Besatzhöhe · rubber trim · taille garniture · altura goma/mm:	25
			Besatzmaterial · bristle · matériel · material:	PET RC Ø 0,40
0-125°C  				



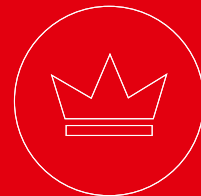



RECYCLED.
FOR NATURE.



<h2>98840RC</h2> <p>"in-up" Großraumbesen "in-up" great-room-broom "in-up" balai pour grands espaces "in-up" escobillone para grandes espacios</p>	 <p>mind./min. 98,5% RC</p>	<p>Körper · block · corps · cuerpo: PP RC</p> <p>Maße · size · mesure · medidas/mm: 410 x 110 x 140</p> <p>Besatzhöhe · rubber trim · taille garniture · altura goma/mm: 65</p> <p>Besatzmaterial · bristle · matériel · material: PET RC Ø 0,40</p>	<p>0-125°C</p>  
			

<h2>99040RC</h2> <p>"in-up" Großraumbesen "in-up" great-room-broom "in-up" balai pour grands espaces "in-up" escobillone para grandes espacios</p>	 <p>mind./min. 98,5% RC</p>	<p>Körper · block · corps · cuerpo: PP RC</p> <p>Maße · size · mesure · medidas/mm: 420 x 110 x 140</p> <p>Besatzhöhe · rubber trim · taille garniture · altura goma/mm: 75</p> <p>Besatzmaterial · bristle · matériel · material: PET RC Ø 0,20</p>	<p>0-110°C</p>  
			

<h2>99240RC</h2> <p>"in-up" Großraumbesen "in-up" great-room-broom "in-up" balai pour grands espaces "in-up" escobillone para grandes espacios</p>	 <p>mind./min. 98,5% RC</p>	<p>Körper · block · corps · cuerpo: PP RC</p> <p>Maße · size · mesure · medidas/mm: 425 x 120 x 140</p> <p>Besatzhöhe · rubber trim · taille garniture · altura goma/mm: 75</p> <p>Besatzmaterial · bristle · matériel · material: PET RC Ø 0,80/0,60</p>	<p>0-125°C</p>  
			

<h2>972RC</h2> <p>"in-up" Aluminiumstiel "in-up" aluminium handle "in-up" manche aluminium "in-up" mango de aluminio</p>	<p>Maße · size · mesure · medidas/mm: 1420 x Ø 42</p> <p>Außen-Ø · Ø ext./mm: 22</p> <p>Wandstärke · thickness · paroi · espesor/mm: 1,0</p> <p>Material · material · matériel · material: ALU</p>	<p>mind./min. 86% RC</p>	<p>-20-100°C</p>     
			

METAL DETECT & X-RAY



FOOD SAFETY - DETEKTIERBARE UND RÖNTGENSICHTBARE AUSRÜSTUNG IN haug basic & PREMIUM HYGIENE REINIGUNGSBÜRSTEN UND ARBEITSGERÄTEN



FOOD SAFETY - DETECTABLE AND X-RAY VISIBLE EQUIPMENT IN haug basic & PREMIUM HYGIENE BRUSHES AND TOOLS

Warum benötigt man detektierbare Bürsten?

Da nicht nur im Produktionsprozess Verunreinigungen, wie Metall, Glas, Kunst- und Gummistoffe, ... eindringen können, sondern auch bei Wartungs- und Reinigungsarbeiten, müssen diese Fremdkörper von Metalldetektoren und Röntgenstrahlen erfasst und erkannt werden.

Risiken ohne detektierbare Bürsten?

- mangelhafte Produkte
- teure Rückrufaktionen
- Ruf des Unternehmens
- verletzte Personen
- Haftung

Wer benötigt detektierbare Bürsten?

- Lebensmittelindustrie (für Mensch und Tier)
- Getränkeindustrie
- Pharmaindustrie
- Kosmetikindustrie
- Textilindustrie
- viele andere

Was ist detektierbar in Bürsten von haug bürsten?

- Körper der Bürsten und Arbeitsgeräte
- Borsten
- ➔ haug bürsten bietet ein Sortiment aus metall- und X-Ray-detektierbaren Reinigungsartikeln an, die durch ihre Materialzusammensetzung von Metall- und X-Ray-Detektoren identifiziert werden können. Somit ist die Einhaltung von Industriestandards wie HACCP und gesetzlichen Auflagen sicher zu stellen.

basic und PREMIUM Sortiment

haug bürsten bietet 2 Qualitätsstufen an: **basic** als Standard und **PREMIUM** mit einer mehrfach besseren Detektierbarkeit der Körper und in verschiedenen Farben.

Was ist zu tun vor der ersten Verwendung?

Die Kalibrierung der Inspektionssysteme ist mit der gebotenen Sorgfalt und nach den Vorschriften des Herstellers vorzunehmen. Ein Test der Detektionsempfindlichkeit ist zwingend empfohlen. Für die Kalibrierung der Systeme stehen dem Material entsprechende Einstell-Referenzteile in Form von Testkugeln, -würfel und -besatzmaterialien in unterschiedlichen Größen zur Verfügung.

Maßgebliche Erkennungsmerkmale für Fremdkörper?

- Größe
- Ausrichtung und Geschwindigkeit der Verunreinigung
- Art der Nahrung oder Produkt
- Art des Metalls im verunreinigten Produkt
- Verpackung
- Dichte
- Maschine (Einstellung, Empfindlichkeit, Alter, ...)

Garantie?

haug bürsten übernimmt aufgrund unterschiedlichster Detektionsbedingungen keine Garantie für eine 100%ige Erkennung und kann daher für direkte und indirekte Sach- und Personenschäden nicht haftbar gemacht werden. Die Produkte wurden und werden immer wieder bei diversen Lebensmittelherstellern unter verschiedenen Anwendungsbedingungen, wie z. B. nass und trocken, geprüft. Dabei wurden die Proben zuverlässig erkannt.

Unbedenkliche Verwendung?

Selbstverständlich sind alle zur Herstellung der METAL und X-RAY DETECT Produkte verwendeten Materialien gemäß der VO (EG) 1935/2004 unbedenklich und insbesondere nach der VO 10/2011 geprüft und somit **lebensmittelgeeignet**. Die Ausrüstung und Herstellung entspricht den Vorschriften des F.E.I.B.P.

Why are detectable brushes needed?

Metal, glass, plastic or rubber contamination can't happen only during the production process but also during maintenance and cleaning, so also contaminations of cleaning equipment have to be found and identified by the metal and x-ray detectors.

Risks without detected brushes?

- defective or damaged products
- expensive product recalls
- company's reputation
- injured persons
- liability

Who needs detectable brushes?

- food industry (human and animal)
- beverage
- pharmaceuticals
- cosmetics
- textiles
- many others

What is detected in brushes from haug bürsten?

- brush body and tools
- bristles
- ➔ haug bürsten offers an assortment of detectable cleaning articles which can be identified by their material composition of metal and X-ray detectors. Compliance with industrial standards such as HACCP and legal requirements must be ensured.

basic and PREMIUM assortment

haug bürsten offers 2 quality levels: **basic** as standard and **PREMIUM** with a multiply better detectability of the bodies and tools and in different colours.

What to do before first use?

The calibration of the detection systems has to be done with the necessary care and according to the guidelines of the manufacturer. A test of detection sensitivity is strongly recommended. Detectable testers for bristles and plastics in different forms and sizes are available for the calibration of the systems.

Relevant variables for identifying foreign bodies?

- size
- direction and speed of contaminant
- type of food or product
- type of metal in the contaminant
- packaging
- density
- machine (settings, sensitivity, age, ...)

Guarantee?

haug bürsten can't make any guarantees for a 100% detection because of different conditions and can't be made liable for any direct and indirect material damages and personal injuries. The products have been and are still tested by various food processors under different conditions, like wet and dry and they have been proved to be effective.

Safe and harmless use?

All materials and ingredients used for the production of the METAL and X-RAY DETECT products are of course harmless according to the regulation (EG) 1935/2004, tested according to the regulation VO 10/2011 and **food contact approved**. The equipment and production is in accordance with the charter of the F.E.I.B.P.



SÉCURITÉ ALIMENTAIRE - MATÉRIEL DÉTECTABLE ET RADIOGRAPHIC VISIBLE DANS haug **basic** & **PREMIUM** HYGIÈNE BROSSES DE NETTOYAGE ET OUTILS DE TRAVAIL

Pourquoi avons-nous besoin de brosses détectables?

Comme non seulement les contaminants comme le métal, le verre, les plastiques et les matériaux en caoutchouc peuvent pénétrer pendant le processus de production mais aussi pendant l'entretien et les travaux de nettoyage, ces corps étrangers doivent être reconnus par des appareils d'inspection.

Risques sans brosses détectables?

- Produits défectueux
- Coûts élevés de rappel de produits
- Réputation de l'entreprise
- Personnes blessées
- Responsabilité

Qui a besoin de brosses détectables?

- Industrie alimentaire (pour les humains et les animaux)
- Industrie des boissons
- Industrie pharmaceutique
- Industrie cosmétique
- Industrie du textile
- Beaucoup d'autres

Qu'est ce qui est détectable dans les brosses de haug bürsten?

- Les corps des brosses et autres outils de travail
- Les brosses
- haug bürsten offre une gamme d'articles de nettoyage sensibles aux détecteurs de métaux et aux rayons X, qui peuvent être identifiés par leur composition de matériaux par les détecteurs de métaux et aux rayons X. Ainsi, le respect des normes industrielles comme l'HACCP et les obligations légales sont assurés.

Gamme **basic** et **PREMIUM**

haug bürsten fournit deux niveaux de qualité: **basic** comme standard et **PREMIUM** avec une meilleure multiples détectabilité des corps et de différentes couleurs.

Que faire avant la première utilisation?

Le calibrage des systèmes d'inspection doit être effectué avec le plus grand soin et suivant les prescriptions du fabricant. Un test de sensibilité de détection est absolument recommandé. Des pièces de référence de réglage suivant les matériaux sous la forme de billes, cubes et fibres d'es-sai de différentes tailles sont disponibles pour le calibrage des systèmes.

Essentiel à l'identification des corps étrangers?

- La taille
- L'orientation et la vitesse de la contamination
- Type de produit alimentaire ou produit
- Type de métal dans le produit contaminé
- Emballage
- Densité
- Machine (réglage, sensibilité, âge, ...)

Garantie?

haug bürsten ne garantit pas une reconnaissance à 100% en raison des conditions différentes de détection et ne peut donc pas être rendu responsable des dommages directs ou indirects causés à des personnes et à des biens. Les produits ont été testés et encore être testés par divers fabricants de produits alimentaires dans des conditions diverses, telles que sec et humide. Les échantillons ont été reconnus fiables.

Utilisation sans risques?

Bien sûr, tous les matériaux utilisés pour la fabrication des produits METAL DETECT et X-RAY DETECT selon la directives (EG) 1935/2004 sont inoffensifs et notamment testés selon la directive (UE) 10/2011 et donc **adaptés à une utilisation alimentaire**. La conception et la fabrication sont conformes aux règlements du F.E.I.B.P.



Foto Mettler-Toledo



SEGURIDAD ALIMENTARIA - EQUIPAMIENTO DETECTABLE Y RAYOS X VISIBLES EN CEPILLOS HIGIÉNICOS Y HERRAMIENTAS haug **basic** & **PREMIUM**

¿Por qué son necesarios los cepillos detectables?

La contaminación por metal, vidrio, plástico o goma no solamente puede suceder durante el proceso de producción, sino que también durante el mantenimiento y la limpieza, por lo que la contaminación de equipos de limpieza tiene que ser identificada por los detectores.

¿Riesgos sin cepillos detectables?

- Productos dañados o defectuosos
- Caras devoluciones de productos
- Daño a la reputación de la compañía
- Personas lesionadas
- Responsabilidad legal

¿Quién necesita los cepillos detectables?

- Industria alimentaria (humana como animal)
- Empresas de bebestibles
- Empresas farmacéuticas
- Empresas de cosméticos
- Empresas textiles
- Muchas otras

¿Qué es detectable en los cepillos de haug bürsten?

- Cuerpo del cepillo y herramientas
- Cerdas
- haug bürsten ofrece una variedad de artículos de limpieza detectables que pueden ser identificados por su composición material de metal y detectores de rayos -X. Debe garantizarse la adhesión a estándares industriales como HACCP y otros requerimientos legales.

Variedad **basic** y **PREMIUM**

haug bürsten ofrece 2 niveles de calidad: **basic** como estándar y **PREMIUM** con cuerpos y herramientas mucho más detectables y en diferentes colores.

¿Qué hacer antes del primer uso?

La calibración de los sistemas de detección debe ser hecha con el cuidado necesario y de acuerdo con la guía de la manufacturera. Una prueba de sensibilidad de detección es extremadamente recomendable. Probadores detectables para plásticos y cerdas de tamaños y formas diferentes están disponibles para la calibración de los sistemas.

¿Variables relevantes para identificar cuerpos extraños?

- Tamaño
- Dirección y velocidad del contaminante
- Tipo de alimento o producto
- Tipo de metal en el contaminante
- Empaque
- Densidad
- Máquina (configuración, sensibilidad, antigüedad, ...)

¿Garantía?

haug bürsten no puede garantizar el 100% de la detección debido a diferentes condiciones y no puede hacerse responsable por cualquier daño directo o indirecto o lesiones personales. Los productos han sido y seguirán siendo probados por varias procesadoras de alimentos bajo diferentes condiciones como humedad y sequedad y han demostrado ser efectivas.

¿Uso seguro y sin daños?

Todos los materiales e ingredientes usados para la producción de los productos METAL y X-RAY DETECT son, por supuesto, inocuos de acuerdo al reglamento (EG) 1935/2004, probados de acuerdo al reglamento (EU) 10/2011 y **aprobados para el contacto con alimentos**. El equipamiento y producción están acordes con el acta de la F.E.I.B.P.



Foto Mettler-Toledo

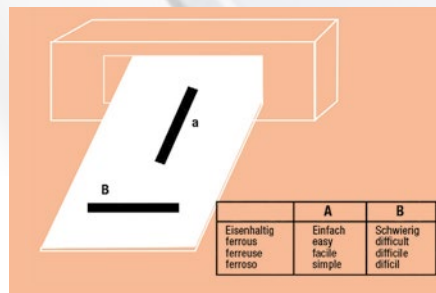







METAL DETECT & X-RAY

METAL DETECT-PRODUKTE • METAL DETECT-PRODUCTS •
METAL DETECT-PRODUITS • METAL DETECT-PRODUCTOS

BÜRSTEN • BRUSHES • BROSSES • CEPILLOS

1458	basic		Körper · block · corps · cuerpo:	PP METDEC
			Maße · size · mesure · medidas/mm:	310 x 30 x 55
Stielbürste schmal handle brush slim brosses universelle étroite cepillo universal estrecho			Besatzhöhe · bristle trim · taille garniture · altura cerda/mm:	23
			Material · bristle · matériel · material:	PBT Ø 0,60 METDEC 
			-20-140°C	 HACCP  

14592	PREMIUM		Körper · block · corps · cuerpo:	PP METDEC
			Maße · size · mesure · medidas/mm:	310 x 30 x 55
Stielbürste schmal handle brush slim brosses universelle étroite cepillo universal estrecho			Besatzhöhe · bristle trim · taille garniture · altura cerda/mm:	23
			Material · bristle · matériel · material:	PBT Ø 0,60 METDEC 
			-20-140°C	 HACCP  

	basic		PREMIUM
	81248		812492
81248/812492	Länge · length · longueur · largo/mm:	320	
	Ø/mm:	70	
Rohrbürste tube-brush écouvillon hisopo limpia-tubos	Besatzlänge · bristle length · longueur matériel · largo material/mm:	70	
	Besatzmaterial · bristle · matériel · material:	PBT Ø 0,60 METDEC 	
	Material · bristle · matériel · material:	V2A Edelstahl draht · V2A stainless steel wire · fil d'acier inox V2A · alambre acero inox V2A	
			-20-140°C
			 HACCP  

83928	basic		Körper · block · corps · cuerpo:	PP METDEC
			Maße · size · mesure · medidas/mm:	220 x 15 x 45
Fugenbürste joint-brush brosse joints cepillo articulado			Besatzhöhe · bristle trim · taille garniture · altura cerda/mm:	19
			Material · bristle · matériel · material:	PBT Ø 0,60 METDEC 
			-20-140°C	 HACCP  

						
83928	839292	8392990	8392991	8392992	8392993	8392994



87408/874092	basic	PREMIUM	Körper · block · corps · cuerpo:	PP METDEC
			Maße · size · mesure · medidas/mm:	Ø 120 x 135
Wolfbürste turk's head-brush brosse cylindrique pour hachoirs et cuves hisopo cilíndrico	87408	874092	Besatzhöhe · bristle trim · taille garniture · altura cerda/mm:	30
			Besatzmaterial · bristle · matériel · material:	PBT Ø 0,60 METDEC 
		-20-140°C   HACCP  		

87428/874292	basic	PREMIUM	Körper · block · corps · cuerpo:	PP METDEC
			Maße · size · mesure · medidas/mm:	400 x Ø 90
Wolfbürste turk's head-brush brosse cylindrique pour hachoirs et cuves hisopo cilíndrico	87428	874292	Besatzhöhe · bristle trim · taille garniture · altura cerda/mm:	30
			Besatzmaterial · bristle · matériel · material:	PBT Ø 0,60 METDEC 
		-20-140°C   HACCP  		

87438	basic	
	Knopfbürste knob-brush brosse ronde cepillo redondo	
Körper · block · corps · cuerpo:	PP METDEC	
Maße · size · mesure · medidas/mm:	Ø 135 x 100	
Besatzhöhe · bristle trim · taille garniture · altura cerda/mm:	43	
Material · bristle · matériel · material:	PBT Ø 0,60 METDEC 	
-20-140°C  HACCP  		

874392	PREMIUM	
	Knopfbürste knob-brush brosse ronde cepillo redondo	
Körper · block · corps · cuerpo:	PP METDEC	
Maße · size · mesure · medidas/mm:	Ø 135 x 100	
Besatzhöhe · bristle trim · taille garniture · altura cerda/mm:	43	
Material · bristle · matériel · material:	PBT Ø 0,60 METDEC 	
-20-140°C  HACCP  		

87558/875592	basic	PREMIUM	Körper · block · corps · cuerpo:	PP METDEC
			Maße · size · mesure · medidas/mm:	490 x 120 x 73
Kutterbürste cutter-brush brosse pour hachoirs cepillo para laminadora	87558	875592	Besatzhöhe · bristle trim · taille garniture · altura cerda/mm:	45
			Besatzmaterial · bristle · matériel · material:	PBT Ø 0,60 METDEC 
		-20-140°C  HACCP  		

METAL DETECT & X-RAY

METAL DETECT-PRODUKTE · METAL DETECT-PRODUCTS ·
METAL DETECT-PRODUITS · METAL DETECT-PRODUCTOS

<h2>87608/876092</h2> <p>Kesselbürste tank-brush brosse pour tanks hisopo cilindrico</p>	<p>basic</p>  <p>87608</p>	<p>PREMIUM</p>  <p>876092</p>	<p>Körper · block · corps · cuerpo: PP METDEC</p> <p>Maße · size · mesure · medidas/mm: 200 x 125 x 105</p> <p>Besatzhöhe · bristle trim · taille garniture · altura cerda/mm: 35</p> <p>Besatzmaterial · bristle · matériel · material: PBT Ø 0,60 METDEC</p>	<p>-20-140°C</p>    
				

<h2>88208</h2> <p>Stielbürste mit kurzem Griff churn-brush with short handle brosse à manche court cepillo mango corto</p>	<p>basic</p> 	<p>Körper · block · corps · cuerpo: PP METDEC</p> <p>Maße · size · mesure · medidas/mm: 260 x 72 x 70</p> <p>Besatzhöhe · bristle trim · taille garniture · altura cerda/mm: 35</p> <p>Besatzmaterial · bristle · matériel · material: PBT Ø 0,60 METDEC</p>	<p>-20-140°C</p>   			
						
<p>basic</p>  <p>88208</p>	<p>PREMIUM</p>  <p>882092</p>	<p>PREMIUM</p>  <p>8820990</p>	<p>PREMIUM</p>  <p>8820991</p>	<p>PREMIUM</p>  <p>8820992</p>	<p>PREMIUM</p>  <p>8820993</p>	<p>PREMIUM</p>  <p>8820994</p>

<h2>883092</h2> <p>Waschbürste rund hand-scrub-brush round brosse à main ronde cepillo de mano para fregar redondo</p>	<p>PREMIUM</p> 	<p>Körper · block · corps · cuerpo: PP METDEC</p> <p>Maße · size · mesure · medidas/mm: 205 x 65 x 55</p> <p>Besatzhöhe · bristle trim · taille garniture · altura cerda/mm: 30</p> <p>Besatzmaterial · bristle · matériel · material: PBT Ø 0,60 METDEC</p>	<p>0-140°C</p>   			
						
<p>basic</p>  <p>88308</p>	<p>PREMIUM</p>  <p>883092</p>	<p>PREMIUM</p>  <p>8830990</p>	<p>PREMIUM</p>  <p>8830991</p>	<p>PREMIUM</p>  <p>8830992</p>	<p>PREMIUM</p>  <p>8830993</p>	<p>PREMIUM</p>  <p>8830994</p>

<h2>88938/889392</h2> <p>Handbesen hand-brush balayette cepillo de mano</p>	<p>basic</p>  <p>88939</p>	<p>PREMIUM</p>  <p>889392</p>	<p>Körper · block · corps · cuerpo: PP METDEC</p> <p>Maße · size · mesure · medidas/mm: 350 x 90 x 90</p> <p>Besatzhöhe · bristle trim · taille garniture · altura cerda/mm: 50</p> <p>Besatzmaterial · bristle · matériel · material: PBT Ø 0,35 METDEC</p>	<p>-20-140°C</p>   
				



889492	PREMIUM		Körper · block · corps · cuerpo:	PP METDEC		
	Handbesen hand-brush balayette cepillo de mano		Maße · size · mesure · medidas/mm: 350 x 90 x 90 Besatzhöhe · bristle trim · taille garniture · altura cerda/mm: 45 Besatzmaterial · bristle · matériel · material: PBT Ø 0,60 METDEC 	-20-140°C HACCP 		
basic	PREMIUM	PREMIUM	PREMIUM	PREMIUM	PREMIUM	PREMIUM
88948	889492	8894990	8894991	8894992	8894993	8894994

89008	basic		Körper · block · corps · cuerpo:	PP METDEC		
	Stielbürste mit langem Griff churn-brush with long handle brosse à manche long cepillo con mango largo		Maße · size · mesure · medidas/mm: 400 x 48 x 70 Besatzhöhe · bristle trim · taille garniture · altura cerda/mm: 35 Besatzmaterial · bristle · matériel · material: PBT Ø 0,60 METDEC 	-20-140°C HACCP 		
basic	PREMIUM	PREMIUM	PREMIUM	PREMIUM	PREMIUM	PREMIUM
89008	890092	8900990	8900991	8900992	8900993	8900994











89068	basic		Körper · block · corps · cuerpo:	PP METDEC
	Zylinderbürste cylinder-brush brosse pour cylindres cepillo-cilindro		Maße · size · mesure · medidas/mm: 320 x Ø 70 Besatzhöhe · bristle trim · taille garniture · altura cerda/mm: 30 Besatzlänge · bristle length · longueur matériel · largo material/mm: 70 Besatzmaterial · bristle · matériel · material: PBT Ø 0,60 METDEC 	-20-140°C HACCP

890692	PREMIUM		Körper · block · corps · cuerpo:	PP METDEC
	Zylinderbürste cylinder-brush brosse pour cylindres cepillo-cilindro		Maße · size · mesure · medidas/mm: 320 x Ø 70 Besatzhöhe · bristle trim · taille garniture · altura cerda/mm: 30 Besatzlänge · bristle length · longueur matériel · largo material/mm: 70 Besatzmaterial · bristle · matériel · material: PBT Ø 0,60 METDEC 	-20-140°C HACCP







METAL DETECT & X-RAY

METAL DETECT-PRODUKTE · METAL DETECT-PRODUCTS ·
METAL DETECT-PRODUITS · METAL DETECT-PRODUCTOS

HANDSCHAUFELN · HAND SCOOPS · PELLES À MAIN · PORUÑAS

<h3>892292</h3> <p>Handschaufel groß hand scoop big pelle à main grande poruña de mano grande</p>		<p>Körper · block · corps · cuerpo: PP METDEC</p>	<p>Maße · size · mesure · medidas/mm: 328 x 136 x 79</p>			
		<p>Anwendung · use · usage · uso: Fassungsvermögen · capacity · capacité · capacidad 1,3 l / ~1300g</p>	<p>-20-80°C  HACCP  </p>			
<p>basic </p> <p>89228</p>	<p>PREMIUM </p> <p>892292</p>	<p>PREMIUM </p> <p>8922990</p>	<p>PREMIUM </p> <p>8922991</p>	<p>PREMIUM </p> <p>8922992</p>	<p>PREMIUM </p> <p>8922993</p>	<p>PREMIUM </p> <p>8922994</p>

<h3>89268/892692</h3> <p>Handschaufel klein hand scoop small pelle à main petite poruña de mano pequeña</p>	 	<p>Körper · block · corps · cuerpo: PP METDEC</p>	<p>Maße · size · mesure · medidas/mm: 280 x 110 x 66</p>			
		<p>Anwendung · use · usage · uso: Fassungsvermögen · capacity · capacité · capacidad 0,7 l / ~700g</p>	<p>-20-80°C  HACCP  </p>			
<p>basic </p> <p>89268</p>	<p>PREMIUM </p> <p>892692</p>	<p>PREMIUM </p> <p>8922990</p>	<p>PREMIUM </p> <p>8922991</p>	<p>PREMIUM </p> <p>8922992</p>	<p>PREMIUM </p> <p>8922993</p>	<p>PREMIUM </p> <p>8922994</p>

<h3>17792</h3> <p>Kehrschaufel dustpan pelle pala de mano</p>		<p>Körper · block · corps · cuerpo: PP METDEC</p>	<p>Maße · size · mesure · medidas/mm: 350 x 222 x 70</p>			
		<p>Anwendung · use · usage · uso: Fassungsvermögen · capacity · capacité · capacidad 0,8 l / ~800g</p>	<p>0-80°C  HACCP  </p>			
<p>basic </p> <p>1778</p>	<p>PREMIUM </p> <p>17792</p>	<p>PREMIUM </p> <p>177990</p>	<p>PREMIUM </p> <p>177991</p>	<p>PREMIUM </p> <p>177992</p>	<p>PREMIUM </p> <p>177993</p>	<p>PREMIUM </p> <p>177994</p>



Werksfoto Mettler-Toldeo

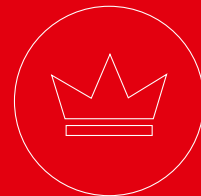

SPACHTELN + SCHABER • SPATULAS + SCRAPERS • SPATULES + RACLOIRS • ESPÁTULAS + RASPADORES

892392	PREMIUM		Körper • block • corps • cuerpo:	PP METDEC		
			Maße • size • mesure • medidas/mm:	250 x 110 x 18		
Spachtel spatula spatule espátula		-20-80°C HACCP				
basic	PREMIUM	PREMIUM	PREMIUM	PREMIUM	PREMIUM	PREMIUM
89238	892392	8923990	8923991	8923992	8923993	8923994

89308	basic		Körper • block • corps • cuerpo:	PP METDEC
			Maße • size • mesure • medidas/mm:	150 x 100 x 2
Schaber klein scraper small racloir petit raspador pequeño		Anwendung • use • usage • uso: flexibel • flexible • flexible • flexible		
		-20-80°C HACCP		

893092	PREMIUM		Körper • block • corps • cuerpo:	PP METDEC
			Maße • size • mesure • medidas/mm:	150 x 100 x 2
Schaber klein scraper small racloir petit raspador pequeño		Anwendung • use • usage • uso: flexibel • flexible • flexible • flexible		
		-20-80°C HACCP		

89318	basic		Körper • block • corps • cuerpo:	PP METDEC
			Maße • size • mesure • medidas/mm:	230 x 120 x 2
Schaber groß scraper big racloir grand raspador grande		Anwendung • use • usage • uso: flexibel • flexible • flexible • flexible		
		-20-80°C HACCP		

893192	PREMIUM		Körper • block • corps • cuerpo:	PP METDEC
			Maße • size • mesure • medidas/mm:	230 x 120 x 2
Schaber groß scraper big racloir grand raspador grande		Anwendung • use • usage • uso: flexibel • flexible • flexible • flexible		
		-20-80°C HACCP		

METAL DETECT & X-RAY

METAL DETECT-PRODUKTE · METAL DETECT-PRODUCTS ·
METAL DETECT-PRODUITS · METAL DETECT-PRODUCTOS

BESEN + WISCHER · BROOMS + WIPERS · BALAIS + BALAIS-BROSSES · ESCOBILLONES + ESCOBILLONES PARA FREGAR

<h3>888292</h3> <p>Großraumbesen great-room-broom balai pour grands espaces escobillon para grandes espacios</p>	<p>PREMIUM</p> 	<p>Körper · block · corps · cuerpo: PP METDEC</p>	<p>Maße · size · mesure · medidas/mm: 415 x 90 x 105</p>		
		<p>Besatzhöhe · bristle trim · taille garniture · altura cerda/mm: 50</p>	<p>Besatzmaterial · bristle · matériel · material: PBT Ø 0,35 METDEC</p>		
		<p>-20-140°C</p> 			
					
888292	8882990	8882991	8882992	8882993	8882994

<h3>889092</h3> <p>Großraumwischer great-room-wiper balai-brosse escobillon para fregar grandes espacios</p>	<p>PREMIUM</p> 	<p>Körper · block · corps · cuerpo: PP METDEC</p>	<p>Maße · size · mesure · medidas/mm: 410 x 70 x 80</p>		
		<p>Besatzhöhe · bristle trim · taille garniture · altura cerda/mm: 26</p>	<p>Besatzmaterial · bristle · matériel · material: PBT Ø 0,60 METDEC</p>		
		<p>-20-140°C</p> 			
					
889092	8890990	8890991	8890992	8890993	8890994

<h3>889192</h3> <p>Großraumbesen great-room-broom balai pour grands espaces escobillon para grandes espacios</p>	<p>PREMIUM</p> 	<p>Körper · block · corps · cuerpo: PP METDEC</p>	<p>Maße · size · mesure · medidas/mm: 410 x 85 x 105</p>		
		<p>Besatzhöhe · bristle trim · taille garniture · altura cerda/mm: 50</p>	<p>Besatzmaterial · bristle · matériel · material: PBT Ø 0,60 METDEC</p>		
		<p>-20-140°C</p> 			
					
889192	8891990	8891991	8891992	8891993	8891994

<h3>E8H / E92H</h3> <p>Einstell-Referenzteil metal detectable set up tester pièce de référence pour le réglage probador metal detectable para test</p>	<p>basic</p> 	<p>PREMIUM</p> 	<p>Körper · block · corps · cuerpo: PP METDEC</p>	<p>Maße · size · mesure · medidas/mm: 120 x 50 x 10</p>	
			<p>0-80°C</p> 		
					
		E8H	E92H		



STIELE • HANDLES • MANCHES • MANGOS

- Auf Anfrage können weitere Farben oder Reinigungsgeräte metalledetektierbar ausgerüstet werden
- More colours or cleaning utensils can be equipped metal detectable upon request
- D'autres couleurs et outils de nettoyage peuvent être équipés de détecteurs de metal
- Otros colores o equipos de limpieza pueden ser equipados para que sean metal detectables, a pedido

87108

**Aluminiumstiel
aluminium handle
manche aluminium
mango de aluminio**

basic

basic

Maße · size · mesure · medidas/mm:	1450 x Ø 42
Außen-Ø · Ø ext./mm:	25
Wandstärke · thickness · paroi · espesor/mm:	1,5
Material · material · matériel · material:	ALU/ PP METDEC

-20-100°C
HACCP

87158	Maße · size · mesure · medidas/mm:	650 x Ø 42
Aluminiumstiel aluminium handle manche aluminium mango de aluminio	Außen-Ø · Ø ext./mm:	25
	Wandstärke · thickness · paroi · espesor/mm:	1,5
	Material · material · matériel · material:	ALU/ PP METDEC

-20-100°C
HACCP

871592	Maße · size · mesure · medidas/mm:	650 x Ø 42
Aluminiumstiel aluminium handle manche aluminium mango de aluminio	Außen-Ø · Ø ext./mm:	25
	Wandstärke · thickness · paroi · espesor/mm:	1,5
	Material · material · matériel · material:	ALU/ PP METDEC

-20-100°C
HACCP



- Zusätzliche detektierbare Produkte, wie z. B. Stifte, Handschuhe, Pflaster, Haarnetze, Ohrstöpsel, Büroklammern, Messer, etc. auf Anfrage
- Additional detectable products, like e.g. pens, gloves, plasters, hairnets, earplugs, paper clips, knives, etc. on request
- D'autres produits détectables, tel que par exemple stylos, gants, pansements, filet pour cheveux, bouchons d'oreilles, trombones, couteaux, etc. sur demande
- Productos detectables adicionales como p.ej. lápices, guantes, parches, redecillas para el pelo, tapones para oídos, clips, cuchillos, etc., a pedido

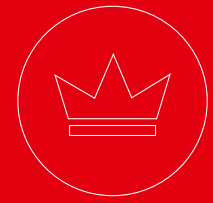

- Bakterienwachstum ohne bakteriellem Schutz
- Growing of bacteria without bacteria protection
- Croissance des bactéries sans protection bacterielle
- Crecimiento de bacterias sin protección bacteriana

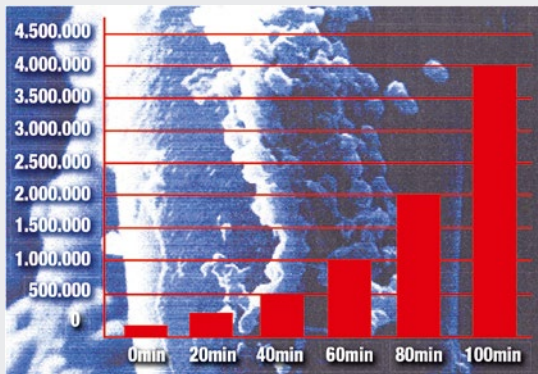

DER ANTIBAKTERIELLE SCHUTZ IN HAUG-HYGIENE-REINIGUNGSBÜRSTEN

Trotz der Verwendung hochwertiger Reinigungsgeräte und chemischen Reinigungsmitteln ist eine Verbreitung von Bakterien weder auf Arbeitsgeräten noch auf Arbeitsflächen zu verhindern.

Die Antwort auf das Risiko der Bakterienübertragung bei der hygienischen Reinigung (Kontamination): haug bürsten hat einsatzgemäß betroffene Produkte mit einem dauerhaften hygienischen Schutz, sowohl im Körper, als auch in den Borsten ausgerüstet. Die antibakteriellen Eigenschaften schützen die Produkte für die gesamte Lebensdauer. Sie können weder abgewaschen, noch abgenutzt werden und sind migrationsfrei.

THE ANTIBACTERIAL PROTECTION IN HAUG-HYGIENIC-BRUSHES

Even with the use of high quality cleaning tools and chemical cleaning agents, it is impossible to avoid bacteria spreading over your tools and working surfaces.

The answer to the risk of contamination during the cleaning process: haug bürsten has fitted the concerned products with a durable hygienic protection in the body and the bristles themselves. The antibacterial characteristics last for the entire lifespan of the product and are free of migration. They will neither be lost by washing nor by extensive use. Prevention of food poisoning bacteria and contamination is therefore guaranteed.

LA PROTECTION ANTIBACTERIELLE DANS LES BROSSES DE NETTOYAGE HAUG HYGIÈNE

Malgré l'utilisation de machines de nettoyage performantes et de produits chimiques de nettoyage ce n'est pas possible d'éviter la propagation des bactéries que ce soit sur les appareils comme sur les surfaces de travail.

La réponse au risque de contamination des bactéries dans le processus de nettoyage: Les brosses haug ont équipé les produits affectés, d'une protection d'hygiène durable que ce soit sur le corps comme sur les brosses elles mêmes. Les caractéristiques antibactérielles protègent les produits pendant toute leur durée de vie. Elles ne peuvent ni être nettoyées ni usées et sont résistantes à la migration.

LA PROTECCIÓN ANTIBACTERIANA EN LOS CEPILLOS HIGIÉNICOS HAUG

Incluso con el uso de herramientas de limpieza de alta calidad y agentes químicos de limpieza, es imposible evitar el esparcimiento de bacterias sobre sus herramientas y superficies de trabajo.

La respuesta a ese riesgo de contaminación durante el proceso de limpieza: haug bürsten ha ajustado esos productos con una protección higiénica y durable en el cuerpo y en las mismas cerdas. Las características antibacterianas duran por todo el ciclo de vida del producto y están libres de migración, en tanto no se perderán por uso extensivo o por limpieza. La prevención contra bacterias que contaminen los alimentos está, por lo tanto, garantizada.

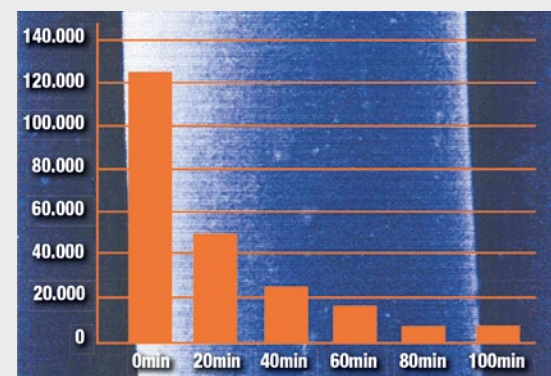

- Bakterienreduktion mit antibakteriellem Schutz
- Reduction of bacteria with antibacterial protection
- Réduction des bactéries avec protection antibacterielle
- Reducción de bacterias con protección antibacteriana



MICROORGANISMEN AUF UNGESCHÜTZTEN FLÄCHEN

- Es sind ca. 3.700 Bakterienspezies weltweit bekannt, wie z. B. Salmonellen, Cholibakterien, Staphylokokken, ...
- Sie vermehren sich als Einzeller durch Zellteilung explosionsartig (Verdoppelung ca. alle 20 Minuten)
- Sie greifen ungehindert an.



MICRO ORGANISMS ON UNPROTECTED SURFACES

- Worldwide there are more than 3.700 different bacteria known to mankind, e.g. salmonellae, escherichia coli, staphylokokkus aureus, ...
- They multiply themselves explosively as single cells by cell division (doubling ca. every 20 minutes)
- They attack unchecked.



LES MICROORGANISMES SUR LES SURFACES NON PROTÉGÉES

- A peu près 3700 sortes de bactéries sont mondialement connues, comme par exemple les salmonelles, les colibactéries, les staphylokokkus, ...
- Elles se propagent d'une façon explosive à partir d'une seule cellule par division cellulaire (duplication toutes les 20 minutes).
- Elles attaquent de manière incontrôlée.



MICRO ORGANISMOS EN SUPERFICIES NO PROTEGIDAS

- Mundialmente hay más de 3700 diferentes bacterias conocidas por la humanidad, como por ejemplo, salmonella, escherichia coli, estafi lococo aureus, ...
- Estas se multiplican a sí mismas de manera explosiva gracias a la división celular (duplicándose cada 20 minutos).
- Atacan de manera incontrolable.



- Schnitt durch einen ungeschützten Körper, z. B. Bürste: Die Bakterien können das Prüfstück (rot) ungehindert angreifen.
- Section through an unprotected body, e.g. a brush: the bacteria are able to attack the test sample (red) unchecked.
- Section à travers un corps non protégé, par exemple une brosse: Les bactéries peuvent attaquer l'échantillon d'essai (rouge) sans être empêché.
- Sección a través de un cuerpo no protegido, por ejemplo, un cepillo: La bacteria puede atacar la muestra de prueba (roja) sin protección.

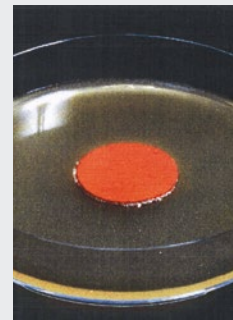

- Petrischale: Eine mit Bakterien angereicherte Nährlösung kann das Prüfstück (rot) ungehindert angreifen.
- Petridish: a nutrient solution enriched with bacteria is able to attack the test sample (red) unchecked.
- Boîte de petri: Une solution nutritive enrichi avec des bactéries peut attaquer l'échantillon d'essai (rouge) sans être empêché.
- Placa de Petri: Una solución con nutrientes enriquecida con bacterias puede atacar la muestra de prueba (roja) sin protección



- Außenfläche einer einzelnen Borste (Monofil): Die Bakterien können die Borste ungehindert angreifen und sich dort festsetzen.
- Outer surface of a single bristle (monofilament): the bacteria are able to attack the bristle unchecked and fix there.
- Surface extérieure d'un poil seul (monofilament): Les bactéries peuvent attaquer le poil sans être empêché et se fixer dessus.
- Superficie exterior de una cerda (monofilamento): La bacteria puede atacar la cerda sin protección y fijarse a ella.



MICROORGANISMEN AUF GESCHÜTZTEN FLÄCHEN

- Die antibakterielle Ausrüstung erfolgt durch Beimengung von Additiven.
- Durch Einwirkung auf die Bakterienzellwand wird bei Lebensmittelkontakt die Nahrungsaufnahme nicht ermöglicht und damit deren Aktivität, Wachstum und Vermehrung nachhaltig verhindert.



MICRO ORGANISMS ON PROTECTED SURFACES

- The antibacterial protection is a result of mixing additives.
- Due to the effect on the cell structure during the food contact, the germ is prevented from food intake and as a result, their activity, growth and reproduction is inhibited for a long time.



LES MICROORGANISMES SUR LES SURFACES PROTÉGÉES

- La protection antibactérielle s'effectue par l'incorporation d'additifs.
- La prise de nourriture n'est plus possible par un effet sur la paroi cellulaire des bactéries pendant le contact avec les produits alimentaires, et donc son activité, sa croissance et sa reproduction sont empêchés de manière efficace.



MICRO ORGANISMOS EN SUPERFICIES PROTEGIDAS

- La protección antibacteriana es el resultado de una mezcla de aditivos.
- Debido al efecto en la estructura de la célula durante el contacto con los alimentos, el germen no puede alimentarse y, como resultado, su actividad, crecimiento y reproducción son inhibidas por un largo tiempo.

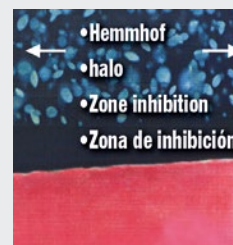

- Schnitt durch einen geschützten Körper, z. B. Bürste: Der Hemmhof ist deutlich zu erkennen.
- Section through a protected body, e.g. a brush: the halo is clearly visible.
- Section à travers un corps protégé, par exemple une brosse: La zone d'inhibition est clairement visible.
- Sección a través de un cuerpo protegido, por ejemplo, un cepillo: La zona de inhibición es claramente visible.



- Petrischale: Eine mit Bakterien angereicherte Nährlösung kann das Prüfstück (rot) nicht angreifen, wie der durchsichtige Kreis (Hemmhof) deutlich zeigt.
- Petridish: a nutrient solution enriched with bacteria is unable to attack the test sample (red) as demonstrated by the clear circle (halo) around it.
- Boîte de petri: Une solution nutritive enrichi avec des bactéries ne peut pas attaquer l'échantillon d'essai (rouge), comme le cercle transparent (zone d'inhibition) indique distinctement.
- Placa de Petri: Una solución con nutrientes enriquecida con bacterias no puede atacar la muestra de prueba (roja) como se demuestra por el círculo transparente alrededor de ella.

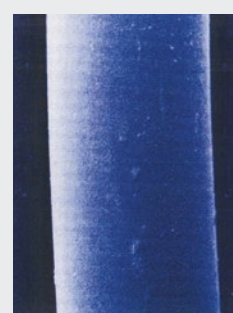

- Außenfläche einer einzelnen Borste (Monofil): Die Bakterien können die Borste nicht angreifen und sich dort nicht festsetzen.
- Outer surface of a single bristle (monofilament): the bacteria are not able to attack the bristle and fix there.
- Surface extérieure d'un poil seul (monofilament): Les bactéries ne peuvent pas attaquer le poil et se fixer dessus.
- Superficie exterior de una cerda (monofilamento): La bacteria no puede atacar la cerda ni fijarse ahí.

15806

Spülbürste rund
dishwashing-brush round
brosse à vaisselle ronde
cepillo para lavaplatos redondo



Körper · block · corps · cuerpo: PP ANTIBAC
Maße · size · mesure · medidas/mm: 255 x 65 x 50
Besatzhöhe · bristle trim · taille garniture · altura cerda/mm: 23
Besatzmaterial · bristle · matériel · material: PBT Ø 0,50 ANTIBAC

0-140°C



HACCP



60106

Scheuerbürste mit Bügel
scrubbing-brush with handle
brosse à main avec manche
cepillo para fregar con asa



Körper · block · corps · cuerpo: PP ANTIBAC
Maße · size · mesure · medidas/mm: 180 x 48 x 70
Besatzhöhe · bristle trim · taille garniture · altura cerda/mm: 22
Besatzmaterial · bristle · matériel · material: PBT Ø 0,50 ANTIBAC

-20-140°C



HACCP



7206

Nagelbürste
nail-brush
brosse à ongles
escobilla de uñas



Körper · block · corps · cuerpo: PS ANTIBAC
Maße · size · mesure · medidas/mm: 97 x 50 x 27
Besatzhöhe · bristle trim · taille garniture · altura cerda/mm: 13/10
Besatzmaterial · bristle · matériel · material: PBT Ø 0,25 ANTIBAC

0-140°C

HACCP



82106

Mehlbesen
flour-brush
balayette à farine
cepillo para harina



Körper · block · corps · cuerpo: PP ANTIBAC
Maße · size · mesure · medidas/mm: 320 x 35 x 78
Besatzhöhe · bristle trim · taille garniture · altura cerda/mm: 55
Besatzmaterial · bristle · matériel · material: PBT Ø 0,25 ANTIBAC

-20-140°C



HACCP



83106

Flachpinsel
pastry-brush
pinceau à pâtisserie
brocha para pastelería



Körper · block · corps · cuerpo: PP ANTIBAC/INOX
Maße · size · mesure · medidas/mm: 225 x 50 x 8
Besatzhöhe · bristle trim · taille garniture · altura cerda/mm: 45
Besatzmaterial · bristle · matériel · material: PBT Ø 0,25 ANTIBAC

-20-140°C



HACCP



87426

Wolfbürste
turk's head-brush
brosse pour hachoir
hisopo cilindrico



Körper · block · corps · cuerpo: PP ANTIBAC
Maße · size · mesure · medidas/mm: 400 x Ø 90
Besatzhöhe · bristle trim · taille garniture · altura cerda/mm: 30
Besatzmaterial · bristle · matériel · material: PBT Ø 0,50 ANTIBAC

-20-140°C



HACCP



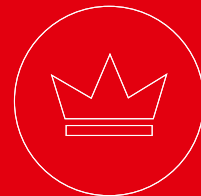

88206		Körper · block · corps · cuerpo:	PP ANTIBAC
		Maße · size · mesure · medidas/mm:	260 x 72 x 70
Stielbürste mit kurzem Griff churn-brush with short handle brosse à manche court cepillo con mango corto		Besatzhöhe · bristle trim · taille garniture · altura cerda/mm:	35
		Besatzmaterial · bristle · matériel · material:	PBT Ø 0,50 ANTIBAC 
		-20-140°C	 HACCP   5

88306		Körper · block · corps · cuerpo:	PP ANTIBAC
		Maße · size · mesure · medidas/mm:	205 x 65 x 55
Waschbürste rund hand-scrub-brush round brosse à main ronde cepillo de mano para fregar redondo		Besatzhöhe · bristle trim · taille garniture · altura cerda/mm:	30
		Besatzmaterial · bristle · matériel · material:	PBT Ø 0,50 ANTIBAC 
		0-140°C	 HACCP   5

88356		Körper · block · corps · cuerpo:	PP ANTIBAC
		Maße · size · mesure · medidas/mm:	225 x 72 x 55
Waschbürste rund hand-scrub-brush round brosse à main ronde cepillo de mano para fregar redondo		Besatzhöhe · bristle trim · taille garniture · altura cerda/mm:	28/36
		Besatzmaterial · bristle · matériel · material:	PBT Ø 0,50 ANTIBAC 
		0-140°C	 HACCP   10

88946		Körper · block · corps · cuerpo:	PP ANTIBAC
		Maße · size · mesure · medidas/mm:	350 x 90 x 90
Handbesen hand-brush balayette cepillo de mano		Besatzhöhe · bristle trim · taille garniture · altura cerda/mm:	45
		Besatzmaterial · bristle · matériel · material:	PBT Ø 0,50 ANTIBAC 
		-20-140°C	 HACCP   5

89006		Körper · block · corps · cuerpo:	PP ANTIBAC
		Maße · size · mesure · medidas/mm:	400 x 48 x 70
Stielbürste mit langem Griff churn-brush with long handle brosse à manche long cepillo con mango largo		Besatzhöhe · bristle trim · taille garniture · altura cerda/mm:	35
		Besatzmaterial · bristle · matériel · material:	PBT Ø 0,50 ANTIBAC 
		-20-140°C	 HACCP   5

Wir liefern diese Artikel aus hygienischen Gründen **einzel**n verpackt im Polybeutel
 For hygienic reason we deliver these articles **each** packed in a polybag
 Nous livrons **chaque** article en polysac pour raison hygiénique
 Por razones higiénicas entregamos **estos** artículos en bolsas de polietileno

WAS BEDEUTET ESD?

ESD steht für „Electric Static Discharge“, das auf deutsch elektro-statische Entladung bedeutet, also antistatisch bzw. elektrisch leitfähig. Darunter versteht man einen Funken, der durch Potenzialdifferenzen (auch Spannung genannt) entsteht.

Warum benötigt man ESD Reinigungsartikel?

Die antistatische Bürste soll bei Verwendung eine statische Aufladung verhindern und Ströme ableiten. Sonst können durch ESD große Schäden mit gravierenden Folgen an elektronischen Bauteilen und Baugruppen entstehen bzw. es besteht das Risiko einer Entzündung von entflammaren Substanzen oder Dämpfen.

Risiken bei Artikeln ohne ESD?

- Mangelhafte Produkte durch unbemerkte Vorschäden
- teure Reparaturen bzw. Folgekosten
- Imageschaden
- Haftung

Wer benötigt ESD Reinigungsartikel?

- Chemieindustrie
- Elektroindustrie
- Automobilindustrie
- Lackindustrie
- Medizintechnik
- Energieerzeuger
- u.v.m.

Was ist ESD in Reinigungsartikeln von haug bürsten?

Sowohl Körper als auch Borsten sind dauerhaft volumenleitfähig und dadurch antistatisch. Das ESD Sortiment von haug bürsten ist leitfähig ausgerüstet und nach DIN 61340-2-3 geprüft. Die Artikel sind mit dem ESD Logo und der Schutzkategorie gekennzeichnet. Der typ. Oberflächenwiderstand beträgt $100\Omega - 10k\Omega$ ($10^2\Omega - 10^4\Omega$) und die Ableitzeit $\pm 1000V < 2s$.

Was ist vor der ersten Verwendung zu tun?

Der Anwender hat sich von der Eignung des Produktes für den vorgesehenen EPA (Electrostatic Protected Area) Einsatzbereich selbst zu überzeugen.

Welche Vorteile hat der Einsatz von ESD Reinigungsartikeln?

Durch die Leitfähigkeit kommt es zum Potentialausgleich zwischen dem Menschen und dem Werkzeug/Artikel. Beim Berühren von Bauteilen, Baugruppen, Behältern bzw. weiteren Gegenständen kommt es dann zu einem definierten Ladungsausgleich, der ESD Schäden verhindert. Ebenso sind alle Artikel dadurch antistatisch. ESD Reinigungsartikel dürfen nicht in Umgebungen eingesetzt werden, in denen mit offenen Spannungen gearbeitet wird.

Haftung?

haug bürsten übernimmt aufgrund der unterschiedlichen Anwendungsgebiete keine Haftung für evtl. Schäden. Der Anwender hat sich vor jedem Einsatz von der Eignung des Produkts für den vorgesehenen EPA (Electrostatic Protected Area) Einsatzbereich selbst zu überzeugen.

Lebensmittelkontakt?

Aufgrund der Zusammensetzung der Rohmaterialien sind die Artikel nicht für den Kontakt mit Lebensmittel geeignet.

WHAT DOES ESD MEAN?

ESD stands for „Electric Static Discharge“, which means antistatic or electrically conductive. This is an electric spark that is created by potential differences (also called voltage).

Why are ESD cleaning utensils needed?

The antistatic brush is intended to prevent static charging and discharge currents during use. Otherwise ESD can cause serious damages with far reaching consequences for electronic components and devices or there is the risk of ignition of flammable substances or vapors.

Risks for articles without ESD?

- defective or damaged products due to unnoticed previous damages
- expensive repairs and follow-up costs
- image damage
- liability

Who needs ESD cleaning utensils?

- chemical industry
- electrical industry
- automotive industry
- paint industry
- medical technology
- energy producers
- many others

What is ESD in cleaning tools from haug bürsten?

Both brush body and bristles are permanent volume conductive and as result antistatic. The ESD assortment by haug bürsten is conductive and tested according to DIN 61340-2-3. All articles are marked with ESD-lo-go and protection category. The typical surface resistance is $100\Omega - 10k\Omega$ ($10^2\Omega - 10^4\Omega$) and the static decay time $\pm 1000V < 2s$.

What to do before first use?

The end user has to convince himself of the suitability of the product for the intended EPA (Electrostatic Protected Area) application.

Advantages of using ESD cleaning tools?

Due to the conductivity there is a potential equalisation between human and tool/article. Touching components, devices, containers or other objects leads to a defined charge equalization which prevents ESD damages. All articles get antistatic thereby as well. ESD cleaning products must not be used in surroundings where open voltages are used.

Liability?

haug bürsten does not assume any liability for possible damages because of various areas of application. The user has to assure himself of the suitability for the intended EPA (Electrostatic Protected Area) area of application before each use.

Contact with food?

Due to the composition of the raw materials the articles are not suitable for contact with food.



QUE SIGNIFIE L'ESD ?

ESD signifie „Electric Static Discharge“ (décharge électrique statique), ça veut dire antistatique ou électriquement conducteur. Il s'agit d'une étincelle provoquée par des différences de potentiel (aussi appelée tension).

Pourquoi a-t-on besoin d'articles de nettoyage ESD ?

La brosse antistatique doit empêcher la charge statique et évacuer les courants lors de l'utilisation. Sinon, les décharges électrostatiques peuvent causer de graves dommages aux composants et ensembles électroniques, avec de graves conséquences, ou du moins il existe un risque d'inflammation des substances ou vapeurs inflammables.

Risques liés aux articles sans ESD ?

- Produits défectueux en raison de dommages antérieurs inaperçus
- Réparations coûteuses ou coûts ultérieurs
- atteinte à l'image de marque
- responsabilité

Qui a besoin de produits d'entretien ESD ?

- secteur chimique
- Industrie électrique
- industrie automobile
- industrie des laques
- technologie médicale
- producteurs d'énergie
- et bien plus encore

Qu'est-ce qui est ESD dans les articles de nettoyage de haug bürsten?

Autant le corps que les poils sont en permanence conducteurs de volume et donc antistatiques. La gamme ESD des brosses haug est équipée de propriétés conductrices et testée selon le DIN 61340-2-3. Les articles sont marqués du logo ESD et de la catégorie de protection. La résistance typiquement de surface est de $100\Omega - 10k\Omega$ ($10^2\Omega - 10^4\Omega$) et le temps de décharge est de $\pm 1000V < 2s$.

Que faut-il faire avant la première utilisation ?

L'utilisateur doit s'assurer de l'adéquation du produit à l'application prévue de l'EPA (Electrostatic Protected Area).

Quels sont les avantages de l'utilisation des produits de nettoyage ESD ?

La conductibilité conduit à l'égalisation des potentiels entre l'être humain et l'outil/article. Lorsque des composants, des sous-ensembles, des récipients ou d'autres objets sont touchés, une compensation de charge définie se produit, ce qui prévient les dommages dus aux décharges électrostatiques. De même, tous les articles sont antistatiques. Les articles de nettoyage ESD ne doivent pas être utilisés dans des environnements où l'on travaille avec des circuits ouverts.

Responsabilité ?

haug bürsten décline toute responsabilité pour d'éventuels dommages dus aux différents domaines d'application. Avant chaque utilisation, l'utilisateur doit s'assurer que le produit convient à l'application prévue de l'EPA (Electrostatic Protected Area).

Contact alimentaire ?

En raison de la composition des matières premières, les articles ne conviennent pas au contact de produits alimentaires.



¿QUÉ SIGNIFICA ESD?

ESD significa „Electric Static Discharge“ (Descarga Electrostática), antiestática o eléctricamente conductor. Esta es una chispa eléctrica que se crea por diferencias de potencial (también llamado voltaje).

¿Por qué se necesitan utensilios de limpieza ESD?

El cepillo antiestático o debe evitar la carga estática y disipar corrientes durante el uso. De lo contrario, una ESD puede causar daños graves con consecuencias de largo alcance para los componentes y dispositivos electrónicos, existiendo también el riesgo de ignición de sustancias o vapores inflamables.

¿Riesgos por artículos no ESD?

- productos defectuosos o dañados por daños previos inadvertidos
- reparaciones costosas y costos de seguimiento
- daño a la imagen
- responsabilidad legal

¿Quién necesita utensilios de limpieza ESD?

- industria química
- industria eléctrica
- industria automotriz
- industria de la pintura
- tecnología médica
- productores de energía
- muchas otras

¿Qué significa ESD en herramientas de limpieza haug bürsten?

Tanto el cuerpo del cepillo como las cerdas tienen un volumen permanente conductivo y, como resultado, son antiestáticos. Los productos ESD de haug bürsten son conductivos y están probados de acuerdo con DIN 61340-2-3. Todos los artículos están marcados con el logo ESD y la categoría de protección. La resistencia superficial típica es $100\Omega - 10k\Omega$ ($10^2\Omega - 10^4\Omega$) y el tiempo de caída estático $\pm 1000 V < 2s$.

¿Qué hacer antes del primer uso?

El usuario final debe convencerse de la idoneidad del producto para la aplicación de la EPA (Electrostatic Protected Area) prevista.

¿Ventajas de usar herramientas de limpieza ESD?

Debido a la conductividad, existe una equalización potencial entre la persona y la herramienta/artículo. Componentes, dispositivos, contenedores u otros objetos en contacto conducen a una equalización de carga definida que evita los daños por ESD. Todos los artículos también se vuelven antiestáticos. Los productos de limpieza ESD no deben utilizarse en entornos donde se utilicen voltajes abiertos.

¿Responsabilidad legal?

haug bürsten no asume ninguna responsabilidad legal por posibles daños debido a diversas áreas de aplicación. El usuario debe asegurarse de la idoneidad para el área de aplicación de la EPA prevista antes de cada uso.

¿Contacto con los alimentos?

Debido a la composición de las materias primas, los artículos no son adecuados para el contacto con los alimentos.



ESD

ESD-PRODUKTE · ESD-PRODUCTS · ESD-PRODUITS · ESD-PRODUCTOS

1997ESD

ESD Kehrgarnitur mit langem Chromstiel
ESD lobby dustpan-set with long chrome handle
ESD pelles et balayette avec manche long en chrome
ESD set de pala basculante + escoba con mango largo de cromo



Körper · block · corps · cuerpo: PP ESD/Chrom
Maße · size · mesure · medidas/mm: 85 x 250 x 1080
Besatzhöhe · bristle trim · taille garniture · altura cerda/mm: 60
Besatzmaterial · bristle · matériel · material: Nyl. 6.0, Ø 0,30 mm

-20-80°C



580ESD

ESD Scheuerbürste rund
ESD scrubbing-brush round
ESD brosse à main ronde
ESD cepillo para fregar redondo



Körper · block · corps · cuerpo: PP ESD
Maße · size · mesure · medidas/mm: 185 x 60 x 45
Besatzhöhe · bristle trim · taille garniture · altura cerda/mm: 26
Besatzmaterial · bristle · matériel · material: Nyl. 6.0, Ø 0,50 mm

0-80°C



8300ESD

ESD Flachpinsel
ESD pastry-brush
ESD pinceau à pâtisserie
ESD broach para pastelerías



Körper · block · corps · cuerpo: PP ESD/INOX
Maße · size · mesure · medidas/mm: 210 x 35 x 8
Besatzhöhe · bristle trim · taille garniture · altura cerda/mm: 45
Besatzmaterial · bristle · matériel · material: Nyl. 6.0, Ø 0,30 mm

-20-80°C



8310ESD

ESD Flachpinsel
ESD pastry-brush
ESD pinceau à pâtisserie
ESD broach para pastelerías



Körper · block · corps · cuerpo: PP ESD/INOX
Maße · size · mesure · medidas/mm: 225 x 50 x 8
Besatzhöhe · bristle trim · taille garniture · altura cerda/mm: 45
Besatzmaterial · bristle · matériel · material: Nyl. 6.0, Ø 0,30 mm

-20-80°C



8392ESD

ESD Fugenbürste
ESD joint-brush
ESD brosse joints
ESD cepillo articulado



Körper · block · corps · cuerpo: PP ESD
Maße · size · mesure · medidas/mm: 220 x 15 x 45
Besatzhöhe · bristle trim · taille garniture · altura cerda/mm: 19
Besatzmaterial · bristle · matériel · material: Nyl. 6.0, Ø 0,50 mm

-20-80°C



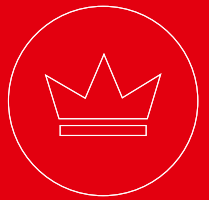

8651ESD			Körper · block · corps · cuerpo:	PP ESD
			Maße · size · mesure · medidas/mm:	625 x 100 x 115
ESD Großraumbesen ESD grest-room-broom ESD brosse joints ESD cepillo articulado			Besatzhöhe · bristle trim · taille garniture · altura cerda/mm:	51
			Besatzmaterial · bristle · matériel · material:	Nyl. 6.0, Ø 0,50 mm 
			-20-80°C  	

8720ESD		Körper · block · corps · cuerpo:	PP ESD	
		Maße · size · mesure · medidas/mm:	310 x 95 x 100	
ESD Besen ESD broom ESD balai ESD escoba			Besatzhöhe · bristle trim · taille garniture · altura cerda/mm:	40
			Besatzmaterial · bristle · matériel · material:	Nyl. 6.0, Ø 0,50 mm 
			-20-80°C  	

8721ESD		Körper · block · corps · cuerpo:	PP ESD	
		Maße · size · mesure · medidas/mm:	315 x 105 x 130	
ESD Besen ESD broom ESD balai ESD escoba			Besatzhöhe · bristle trim · taille garniture · altura cerda/mm:	50
			Besatzmaterial · bristle · matériel · material:	Nyl. 6.0, Ø 0,30 mm 
			-20-80°C  	

8760ESD		Körper · block · corps · cuerpo:	PP ESD	
		Maße · size · mesure · medidas/mm:	200 x 125 x 105	
ESD Kesselbürste ESD tank-brush ESD brosse pour tanks ESD cepillo para tanque			Besatzhöhe · bristle trim · taille garniture · altura cerda/mm:	35
			Besatzmaterial · bristle · matériel · material:	Nyl. 6.0, Ø 0,50 mm 
			-20-80°C  	

8770ESD		Körper · block · corps · cuerpo:	PP ESD	
		Maße · size · mesure · medidas/mm:	310 x 85 x 95	
ESD Wischer ESD wiper ESD frottoir ESD cepillo para fregar			Besatzhöhe · bristle trim · taille garniture · altura cerda/mm:	30
			Besatzmaterial · bristle · matériel · material:	Nyl. 6.0, Ø 0,50 mm 
			-20-80°C  	

8892ESD		Körper · block · corps · cuerpo:	PP ESD	
		Maße · size · mesure · medidas/mm:	350 x 222 x 110	
ESD Kehrgarnitur ESD dustpan-set ESD pelle et balayette ESD set de pala + cepillo			Besatzhöhe · bristle trim · taille garniture · altura cerda/mm:	50
			Besatzmaterial · bristle · matériel · material:	Nyl. 6.0, Ø 0,30 mm 
			-20-80°C  	



ESD

ESD-PRODUKTE · ESD-PRODUCTS · ESD-PRODUITS · ESD-PRODUCTOS

8893ESD

ESD Handbesen
ESD hand-brush
ESD balayette
ESD cepillo de mano



Körper · block · corps · cuerpo: PP ESD
Maße · size · mesure · medidas/mm: 350 x 90 x 90
Besatzhöhe · bristle trim ·
taille garniture · altura cerda/mm: 50
Besatzmaterial · bristle ·
matériel · material: Nyl. 6.0, Ø 0,30 mm

-20-80°C



8894ESD

ESD Handbesen
ESD hand-brush
ESD balayette
ESD cepillo de mano



Körper · block · corps · cuerpo: PP ESD
Maße · size · mesure · medidas/mm: 310 x 40 x 90
Besatzhöhe · bristle trim ·
taille garniture · altura cerda/mm: 45
Besatzmaterial · bristle ·
matériel · material: Nyl. 6.0, Ø 0,50 mm

-20-80°C



177ESD

ESD Kehrschaufel
ESD dustpan
ESD pelle
ESD pala de mano



Körper · block · corps · cuerpo: PP ESD
Maße · size · mesure · medidas/mm: 350 x 222 x 70
Fassungsvermögen · capacity ·
capacité · capacidad: ~0,8l / ~800g

0-80°C



8899ESD

ESD Außenrohrbürste
ESD outer-tube-brush
ESD brosse pour nettoyer
de l'extérieur des tuyaux
ESD hisopo limpia tuberías
y exteriores



Körper · block · corps · cuerpo: PP
Maße · size · mesure · medidas/mm: 190 x 170 x 130
Besatzhöhe · bristle trim ·
taille garniture · altura cerda/mm: 65
Besatzmaterial · bristle ·
matériel · material: Nyl. 6.0, Ø 0,30 mm

-20-80°C



8923ESD

ESD Spachtel
ESD spatula
ESD spatule
ESD espátula



Körper · block · corps · cuerpo: PP ESD
Maße · size · mesure · medidas/mm: 250 x 110 x 18



-20-80°C







8906ESD		Körper · block · corps · cuerpo:	PP ESD
		Maße · size · mesure · medidas/mm:	320 x Ø 70
ESD Rohrbürste ESD tube-brush ESD écouvillon ESD hisopo limpia-tubos		Besatzhöhe · bristle trim · taille garniture · altura cerda/mm:	35
		Besatzmaterial · bristle · matériel · material:	Nyl. 6.0, Ø 0,50 mm 
			-20-80°C 

8930ESD		Körper · block · corps · cuerpo:	PP ESD
		Maße · size · mesure · medidas/mm:	150 x 100 x 2
ESD Schaber klein ESD scraper small ESD racloir petite ESD raspador pequeño		Anwendung · use · usage · uso:	flexibel · flexible · flexible · flexible
			-20-80°C 

8931ESD		Körper · block · corps · cuerpo:	PP ESD
		Maße · size · mesure · medidas/mm:	230 x 120 x 2
ESD Schaber groß ESD scraper big ESD racloir grand ESD raspador grande		Anwendung · use · usage · uso:	flexibel · flexible · flexible · flexible
			-20-80°C 

8933ESD		Körper · block · corps · cuerpo:	PP ESD
		Maße · size · mesure · medidas/mm:	150 x 128 x 37
ESD Schaber klein mit Stielverbindung ESD scraper small with handle fixation ESD racloir petite avec connexion de manche ESD raspador pequeño con conexión de mango		Anwendung · use · usage · uso:	flexibel · flexible · flexible · flexible
			-20-80°C  

8934ESD		Körper · block · corps · cuerpo:	PP ESD
		Maße · size · mesure · medidas/mm:	230 x 148 x 37
ESD Schaber groß mit Stielverbindung ESD scraper big with handle fixation ESD racloir grand avec connexion de manche ESD raspador grande con conexión de mango		Anwendung · use · usage · uso:	flexibel · flexible · flexible · flexible
			-20-80°C  

871090ESD			
	Maße · size · mesure · medidas/mm:	1485 x Ø 40	
ESD Aluminiumstiel ESD aluminium handle ESD manche aluminium ESD mango de aluminio		Außen-Ø · Ø ext./mm:	25
		Wandstärke · thickness · paroi · espesor/mm:	1,5
		Material · material · matériel · material:	ALU
		ALU-Aufhängekappe + Überwurfmutter · alu hanger + collar · alu pingé + bague · alu manija + collar	
			-20-80°C  





ÜBER UNS

haug bürsten wurde 1962 von Traudel und Hans Haug zur industriellen Bürstenproduktion gegründet. Die handwerkliche Tradition des Familienunternehmens in der mittlerweile 6. Generation reicht zurück bis ins Jahr 1836. Von der rund 23.000 m² großen Betriebsfläche des Standortes in Königsbrunn werden ca. 15.000 m² für Produktion, Lager und Verwaltung genutzt.

haug bürsten ist der weltweit bekannte Produzent von qualitativ hochwertigsten Hygienebürsten, die in allen Anwendungsbereichen der Lebensmittelverarbeitenden Branchen eingesetzt werden können. Innovative und kreative Produktideen werden auf Maschinen mit höchster Technologie und anspruchsvollen Rohstoffen hergestellt.

Die Lebensmittelhygiene, Vorschriften und Kontrollen

Nach der Lebensmittelhygiene-Verordnung (LMHV) ist jeder Betrieb, der Lebensmittel herstellt, verarbeitet oder in Verkehr bringt, verpflichtet, im Prozessablauf die für die Lebensmittelsicherheit kritischen Arbeitsstufen zu ermitteln, konsequent zu überwachen und zu dokumentieren sowie angemessene Sicherheitsmaßnahmen festzulegen. Die aktuelle Lebensmittelhygiene-Verordnung aus 2007 löste die Verordnung vom 5. August 1997 ab.

Wir bestätigen für alle Katalogartikel, die mit dem  Symbol gekennzeichnet sind, dass diese den zum Druckzeitpunkt gültigen Vorschriften der VO (EG) 1935/2004, der VO (EU) 10/2011 und Ergänzungen, des LFGB Lebensmittel- und Futtermittelgesetzbuch und des BfR Bund für Risikobewertung entsprechen. Ebenso bestätigen wir für diese Artikel, dass diese nach (EG) 2023/2006 (GMP) gefertigt wurden. Prüfungen der Gesamt- wie der spezifischen Migration wurden durchgeführt und es können der VO (EU) 10/2011 entsprechende Konformitätserklärungen für diese Artikel ausgestellt werden. Die Umsetzung der Hygienevorschriften sowie des HACCP-Konzeptes ist ohne professionelle Reinigungsgeräte nicht möglich. Der Europäische Verband der Bürsten- und Pinselhersteller F.E.I.B.P. hat eine Charta und ein Logo  für Professionelle Hygiene-Bürstenwaren „PHB“ entwickelt, die nur Herstellern von hochqualitativen Hygienebürsten wie auch haug bürsten zugeteilt werden. Hier dürfen z.B. keine Artikel aus Holz, Stahl oder mit geschlitzten Fasern oder Hohlfasern verwendet werden. Der Bundesverband der Lebensmittelkontrolleure empfiehlt haug Hygienebürsten.

Anwendungsbereiche

- ▶ Lebensmittelverarbeitende Industrie: Wurst- und Fleischereibetriebe, Schlachthöfe, Brotfabriken, Fischereibetriebe, Molkereien, Brauereien, Winzereien
- ▶ Bäckereien, Konditoreien
- ▶ Getränkeindustrie
- ▶ Gastronomie, Catering, Großküchen, Kantinen, HORECA
- ▶ Krankenhäuser, Heime
- ▶ Landwirtschaft
- ▶ Reinigungsbetriebe, Gebäudereinigung
- ▶ Chemische Industrie
- ▶ Pharmazeutische Industrie
- ▶ Verpackungsindustrie

Eigenschaften der qualitativ hochwertigen haug Hygieneartikel

1. Kunststoffkörper:

- ▶ handliche ergonomische Griffe aus massivem Vollkunststoff
- ▶ formbeständig, nicht toxisch, säuren- und laugenbeständig, kalte- und hitzebeständig (außer Polystyrol), autoklavierbar (außer Polystyrol), sterilisierbar
- ▶ keine Kontamination durch fremde oder nicht arteigene Mikroorganismen

2. Besatzmaterialien:



- **Polyesterborsten PBT:** formbeständig, nicht toxisch, säuren- und laugenbeständig, geringer Verschleiß, kalte- und hitzebeständig, autoklavierbar bis 134°C, sterilisierbar, lange Lebensdauer
- ▶ **Eigenschaften der Polyesterborsten:** hohe Rückstellelastizität, sehr gutes Aufrichtevermögen, geringe Wasseraufnahme, hohe Hitze- und Chemikalienbeständigkeit
- ▶ keine Kontamination durch fremde oder nicht arteigene Mikroorganismen
- ▶ **Verankerung des Besatzes:** Edelstahl V4A/AISI 316L-Draht, nicht rostend
- ▶ **Farbkodierung/colour-coding:** farbige Besatzmaterialien in 7 Farben weiß, rot, blau, grün, gelb, lila und schwarz werden zur klaren Trennung zwischen einzelnen Arbeits- und Reinigungsbereichen eingesetzt, um Kreuzkontaminationen zu vermeiden. Die Zuordnung der Farben für die Einsatzbereiche ist von den Betrieben individuell festzulegen.
- **PP-Fasern:** geringe Wasseraufnahme, hohe Chemikalienbeständigkeit, wenig hitzeresistent, knickanfällig
- **Nylon:** hohe Wasseraufnahme, schlechtes Verhältnis zwischen Trocken- und Nasssteifheit, Unverträglichkeit gegen Mineralsäuren und deren Lösungen
- **Naturfasern, Hohlfasern und geschlitzte Fasern** sind in kritischen Hygienebereichen nicht PHB konform

3. Wasserschieber:

Schwämme müssen nach den Vorgaben der FEIBP im Bereich der Lebensmittelhygiene mindestens 95% geschlossene Zellen aufweisen. Die Wasseraufnahme unserer Zellkautschukstreifen liegt unter 5%, die der Lebensmittelgummis sogar unter 1%. In alle unsere Wasserschieber aus Kunststoff sind auch Ersatzleisten einsetzbar.

4. Stiele:

Stiele in eloxiertem Alurohr, Fiberglas, Kunststoff, Alurohr/Kunststoff und rilsanisiertem Stahlrohr mit original haug 8-Kant Steck-/Schraubsystem sorgen für eine professionelle, extrem beanspruchbare Verbindung zum Reinigungsgerät.

- ▶ **einfache Handhabung:** „einstecken – zuschrauben – 100%-iger Halt“
Alle Stiele mit „“ passen zu allen Artikeln mit dem  Symbol, egal welchen Außen-Durchmesser der Stiel hat. Die belastbaren Qualitäten lassen Biegekräfte von mehr als 65 kg zu. Stiele mit Kerbbeschädigungen müssen aus Sicherheitsgründen ausgetauscht werden. Für Arbeitsgeräte ab 400 mm Breite empfehlen wir einen Stiel mit einem Außen-Durchmesser von 25 mm.

5. Pflege und Aufbewahrung:

Durch den hohen Qualitätsstandard lassen sich unsere Produkte nach Gebrauch durch thermische und fluide Behandlung in hygienisch unbedenklicher Einsatzbereitschaft halten. Es ist darauf zu achten, dass Heißluft- oder Dampfbehandlungen ohne Druckbelastung des Besatzmaterials erfolgen.

Reinigungsgeräte sollten in gut belüfteten Räumen oder Schränken, hängend und ohne Boden- und Wandkontakt aufbewahrt werden. Reinigungsgeräte sollten ausgetauscht werden, wenn die Borsten verfilzt, verformt, beschädigt oder verschlissen sind oder der Bürstenkörper beschädigt ist.

haug bürsten – Ihr Partner für professionelle Reinigung





ABOUT US

haug bürsten was founded in 1962 by Traudel and Hans Haug for the industrial brushes production. The artisan tradition of the family business in the meanwhile 6th generation dates back to the year 1836. Approximately 15.000 m² of the 23,000 m² factory area of the site in Königsbrunn are used for production, warehouse and administration.

haug bürsten is known worldwide for being the manufacturer of hygiene-brushes with the highest quality which can be used in all food-processing companies. We produce our innovative and creative brush-ideas with equipments of highest technology and upmarket raw-materials.

Food hygiene, regulations and controls

According to the Food Hygiene Regulation, every company that produces, processes or sells food is obliged to determine the work stages in the process flow that are critical for food safety, to monitor them consistently and to document them and to define appropriate safety measures. The current food hygiene regulation from 2007 replaced the regulation of August 5, 1997.

We confirm for all articles in our catalogue which are marked with  that these correspond to the valid Regulation (EG) 1935/2004, Regulation (EU) 10/2011 and amendments, the LFGB German Food and Feed Legislation and the BfR German Federal Association for Risk Assessment at the time of printing. We also confirm that these articles have been manufactured according to the Regulation (EG) 2023/2006 (GMP). Migration examinations have been carried out and corresponding declarations of conformity for these articles can be issued to Regulation (EU) 10/2011 accordingly. The HACCP-concept can only work out with a careful cleaning and disinfection and haug bürsten follows these hygiene regulations with their hygienic brushes. The european federation of brushware manufacturer F.E.I.B.P. has established a charter and a logo  for Professional Hygiene Brushware „PHB“ which will be assigned only to manufacturers of high quality professional brushware like haug bürsten is. For example, no articles made of wood, steel or with fl agged or hollow bristles are allowed to use. The german association for the food quality control recommends haug hygienic brushes.

fields of application

- ▶ food-processing companies: butchers, slaughterhouses, bread factories, fisheries, dairies, breweries, vineries
- ▶ bakeries, pastry shops
- ▶ beverage industries
- ▶ gastronomies, caterings, large kitchens, canteens, HORECA
- ▶ hospitals, homes, health care
- ▶ agriculture
- ▶ cleaning services, contract cleaners
- ▶ chemical industries
- ▶ pharmaceutical industries
- ▶ packaging industries

characteristics of the high quality haug hygiene articles

1. plastic blocks:

- ▶ ergonomic handles made of solid full plastic
- ▶ shape-retaining, non-toxic, resistant to acids and alkalis, long durability, cold- and heatresistant (except polystyrene), autoclavable (except polystyrene), sterilizable
- ▶ cleaning without cross-contamination

2. bristles:

- **polyester PBT bristles:** shape-retaining, non-toxic, resistant to acids and alkalis, long durability, cold- and heatresistant, autoclavable up to 134° C, sterilizable, long life span
- ▶ **characteristics of polyester PBT:** high resetting elasticity, high putting up ability, low water absorption, high heat- and chemicals resistance
- ▶ cleaning without cross-contamination
- ▶ **wire:** stainless steel V4A/AISI 316L wire, not attracting rust
- ▶ **colour-coding:** 7 different bristle colours white, red, blue, green, yellow, purple and black can be used in different areas of application to avoid cross contaminations. Every company has the opportunity to specify their different cleaning areas with a different colour.
- **PP-fibres:** water absorption, high resistance against chemicals, less heat resistant, bend slightly
- **Nylon fibers:** high water absorption, bad relation between the dry- and wet stiffness, incompatibility against mineral acids and their solutions
- **Natural, hollow and flagged fibres** are not PHB conform in critical hygienic areas



3. rubber squeegees:

Sponges which are used in hygienic areas must have minimum 95% closed cells, this is written in the FEIBP Charter. The water absorption of our black special rubber strips is under 5%, the water absorption of our food-approved rubbers is even under 1%. Refill rubbers fit in all of our plastic rubbers squeegees.

4. handles:

Handles are in anodised aluminium, fiberglass, plastic, aluminium/plastic and epoxy-lacquered metal, with original 8 edges haug coupling system, excellent for a professional and extremely strong connection to the cleaning equipment.

- ▶ **easy and effective use:** „plug in – screw down – 100 % professional fixation“

All handles with  can be used with all articles with the symbol , irrespective of the exterior diameter of the handle. The strong qualities have bending strengths up to 65 kg. Handles with notch damages must be changed for safety reasons. We recommend a handle with 25 mm exterior diameter for floor articles from 400 mm on.

5. care and storage:



Through our high quality standards there must be no hesitation about the hygienically standards of our products in using them by thermal and fluid treatment. Please pay attention not to put the bristles under pressure while they are under hot heat or steam treatment. Cleaning equipment must be kept in good ventilated rooms or closets in hanging position without floor- or wall contact.

The cleaning equipment should be replaced if the bristles are tangled, deformed, damaged or worn or the plastic body is damaged.

haug bürsten – your partner for professional cleaning

haug bürsten a été fondé en 1962 par Traudel et Hans Haug pour la production industrielle des brosses. La tradition artisanale de l'entreprise familiale remonte à l'année 1836. Environ 15.000 m² de la zone de l'usine de 23.000 m² du site à Königsbrunn sont utilisés pour la production, le stockage et l'administration. **haug bürsten** est le producteur mondialement connu des brosses alimentaires qui sont utilisables dans tous les domaines de la fabrication alimentaire. Nous produisons nos brosses sur des machines de haute technologie avec des matières premières de la plus haute exigence.

Hygiène alimentaire, réglementations et contrôles

Selon la Régulation sur l'hygiène alimentaire, chaque entreprise qui produit, transforme ou commercialise des alimentaires est tenue de déterminer les étapes de travail du flux de processus qui sont critiques pour la sécurité alimentaire, de les surveiller de manière cohérente et de les documenter et de définir la sécurité appropriée mesures. Le règlement d'hygiène alimentaire en vigueur depuis 2007 a remplacé le règlement du 5 août 1997. Nous confirmons que tous les articles du catalogue qui sont marqués avec  correspondent aux directives (EG) 1935/2004, (UE) 10/2011 et à leurs avenants, à la LFGB (loi allemande sur les denrées alimentaires et les aliments pour animaux) et à celles du BfR (Institut fédéral pour l'évaluation des risques) en vigueur au moment de l'impression. Nous confirmons également que ces produits ont été conçus selon la directive (EG) 2023/2006 (GMP). Des tests de migration globale et spécifique ont été réalisés et des certificats de conformité peuvent être délivrés pour ces produits selon la directive (UE) 10/2011. Le respect des réglementations d'hygiène et du concept HACCP peuvent seulement fonctionner avec des appareils de nettoyage professionnels. La fédération européenne de la brosse F.E.I.B.P a crée une charte et un logo  pour les brosses d'hygiène professionnelle „PHB“ qui ne sont assignés qu'aux fabricants de brosses d'hygiène de haute qualité comme haug bürsten. Il est par exemple interdit d'utiliser des articles en bois, en métal ou avec des fibres fleuries ou creuses. L'association nationale des contrôleurs alimentaires conseillent aussi 8 bord brosses haug.

domaines d'application

- ▶ industrie de traitement alimentaire: boucheries abattoirs, usines à pain, poissonneries, laiteries, brasseries, établissements vinicoles
- ▶ boulangeries, pâtisseries
- ▶ industries des boissons
- ▶ gastronomies, Catering, cuisines, cantines, HORECA
- ▶ hôpitaux, maisons d'accueil
- ▶ agriculture
- ▶ entreprises de nettoyage
- ▶ industries chimiques
- ▶ industries pharmaceutiques
- ▶ industries de l'emballage

propriétés de haute qualité des articles de haug hygiène

1. corps en plastique:

- ▶ poignées pratiques et ergonomiques en plastique massif
- ▶ ne se déforme pas, non toxique, résistant aux acides et lessives, de longue durabilité, résistants au froid et la chaleur (sauf polystyrène), autoclavable (sauf polystyrène), stérilisable
- ▶ sans contamination par des micro-organismes étrangers

2. fibres:



- **fibres polyester PBT:** ne se déforme pas, non toxique, résistant aux acides et lessives, de longue durabilité, résistants au froid et la chaleur, autoclavable jusqu' à 134° C, stérilisable, longue durée de vie
- ▶ **propriétés des fibres polyester PBT:** haut élasticité, haute capacité de redressement, faible absorption de l'eau, haute stabilité à la chaleur et aux produits chimiques
- ▶ sans contamination par des micro-organismes étrangers
- ▶ **fixation des fibres:** Fil V4A/AISI 316L, non rouillant
- ▶ **colour-coding:** les matériaux de garniture en couleurs blanc, rouge, bleu, vert, jaune, violet et noir sont utilisés a fin de séparer clairement les différents secteurs de nettoyage et de travail
- ▶ **fibres PP:** faible absorption d'eau, haute résistance aux produits chimiques, peu résistants à la chaleur, tendance à se plier
- ▶ **fibres nylon:** haut absorption d'eau, mauvais rapport entre la rigidité au sec et au mouillé, l'incompatibilité contre les acides minéraux et leurs solutions
- ▶ **Les fibres naturelles, creuses et fleuries** ne sont pas PHB conformes dans les zones critiques d'hygiène

3. raclettes sol:

Les éponges doivent montrer au moins 95% de cellules fermées selon les normes du FEIBP dans le secteur de l'hygiène alimentaire. L'absorption d'eau de nos bandes de caoutchouc cellulaire se trouve en dessous de 5%, celle des caoutchoucs de produits alimentaires en dessous de 1%. Sur toutes nos raclettes sol en matière plastique, des rechanges sont également applicables.

4. manches:

Les tubes sont en aluminium anodisé, fibre de verre, plastique, aluminium/plastique et tube d'acier laqué epoxydé, avec original haug octogonale système de fixation pour une connexion professionnel.

- ▶ **manipulation simple:** "enfoncez - visser - 100% -fixation" Tous les manches avec le symbol „“ s'adaptent à tous les articles avec le symbol , indifféremment du diamètre extérieur du manche. Les manches avec le système original de fixation haug veillent à une liaison professionnelle et extrêmement solide avec les appareils de nettoyage. Ces hautes qualités permettent une force de pliage de plus de 65 kg. Pour des raisons de sécurité, les manches avec des dommages d'entailles doivent être échangées. Pour les outils de travail à partir de 400 mm de largeur, nous conseillons un manche avec un diamètre extérieur de 25 mm.

5. soin et conservation:

Grâce à nos hauts standards de qualité il n'y aucune hésitation sur l'état hygiénique de nos produits à la suite d'un traitement thermique et fluide après usage. Il faut veiller à ce que les traitements d'air chaud ou de vapeur se produisent sans pression sur le matériel. Les appareils de nettoyage doivent être gardés dans des espaces ou des armoires bien aérées, suspendus et sans contact avec la paroi et le sol.

Le matériel de nettoyage doit être remplacé si les poils sont emmêlés, déformés, endommagés ou usés ou si le corps plastique est endommagé.

haug bürsten – Votre partenaire pour le nettoyage professionnel





SOBRE NOSOTROS

haug bürsten fue fundada en 1962 por Traudel y Hans Haug con el fin de producir cepillos industriales. La tradición artesana del negocio familiar data del año 1836. Aproximadamente 15.000 metros cuadrados de los 23.000 que cubre la fábrica situada en Königsbrunn son usados para la producción, almacenamiento y administración.

haug bürsten es conocida mundialmente por ser la empresa de manufactura de cepillos higiénicos con la más alta calidad, los cuáles pueden ser usados en todas las compañías de procesamiento de alimentos. Producimos nuestros innovadores y creativos cepillos con equipamiento de la más alta calidad y con materias primas que resisten las más altas exigencias.

Higiene de los alimentos, reglamentos y controles

De acuerdo con la Regulación de Higiene Alimentaria, toda empresa que produzca, procese o comercialice alimentos está obligada a determinar las etapas de trabajo en el flujo del proceso que son críticas para la seguridad alimentaria, monitorearlas consistentemente y documentarlas y definir la seguridad adecuada. medidas. El reglamento de higiene alimentaria actual de 2007 reemplazó al reglamento del 5 de agosto de 1997. Certificamos que todos los artículos en nuestro catálogo marcados con el  corresponden al Reglamento vigente (EG) 1935/2004, al Reglamento (EU) 10/ 2011 y sus enmiendas, a la LFGB Legislación Alemana sobre Alimentos y Comida, y la BfR Asociación Federal Alemana para la Evaluación de Riesgos al momento de la impresión. También certificamos que estos artículos han sido fabricados de acuerdo con el Reglamento (EG) 2023/2006 (GMP). Se han llevado a cabo exámenes de migración y las correspondientes declaraciones de conformidad para estos artículos pueden ser solicitados bajo el Reglamento (EU) 10/2011. La Federación Europea de Empresas Manufactureras de Cepillos F.E.I.B.P. ha establecido un logo  para los Cepillos de Higiene Profesional, PHB, los cuales son entregados sólo a empresas de manufactura de cepillos profesionales de alta calidad, como es el caso de haug bürsten. Por ejemplo, no se permite el uso de artículos hechos de madera, acero o con cerdas despuntadas o huecas. La Asociación Alemana para el Control de Calidad Alimentaria también recomienda los cepillos higiénicos haug bürsten.

Campos de uso

- ▶ Compañías de procesamiento de alimentos: carnicerías, mataderos, elaboradoras de pan, empresas pesqueras, productoras de lácteos, cervecerías, viñas
- ▶ Panaderías, pastelerías y reposterías
- ▶ Industrias de bebidas
- ▶ Restaurantes, empresas gastronómicas, caterings, cocinerías, bares, HORECA (Hostelería, Restauración y Catering)
- ▶ Hospitales, casas, asistencia médica
- ▶ Agricultura
- ▶ Servicios de limpieza, limpiadores profesionales
- ▶ Industrias Químicas
- ▶ Industrias Farmacéuticas
- ▶ Industrias del Embalaje

Características de los artículos higiénicos haug de alta calidad

1. Cuerpos de plástico:

- ▶ Mangos ergonómicos hecho de plástico macizo
- ▶ Capaces de mantener su forma, no tóxicos, resistentes a ácidos y alcalinos, de alta durabilidad, resistentes a calor y frío (excepto poliestireno), fáciles de esterilizar (excepto poliestireno), esterilizables
- ▶ Limpieza sin contaminación cruzada

2. Cerdas:

- **Cerdas de poliéster PBT:** capaces de mantener su forma, no tóxicas, resistentes a ácidos y alcalinos, de alta durabilidad, resistentes a calor y frío, fáciles de esterilizar hasta 134°C, esterilizables, larga vida útil
- ▶ **Características del poliéster PBT:** de enderezamiento, baja absorción de agua, alta resistencia a los químicos y al calor
- ▶ Limpieza sin contaminación cruzada
- ▶ **Alambre:** V4A/AISI 316L, inoxidable
- ▶ **Códigos de colores:** 7 colores diferentes: blanco, rojo, azul, verde, amarillo, violeta y negro, pueden ser utilizados en diferentes áreas de aplicación para evitar la contaminación cruzada. Cada empresa tiene la oportunidad de especificar sus áreas de limpieza diferentes con un color diferente.
- **Fibras de PP:** baja absorción de agua, alta resistencia contra químicos, menos resistentes al calor, se doblan levemente
- **Fibras de Nylon:** alta absorción de agua, mala relación entre la dureza seca o mojada, incompatibilidad con ácidos minerales y sus soluciones
- **Las fibras despuntadas, huecas y naturales** no se ajustan a los estándares PHB en áreas higiénicas críticas



3. Haraganes de goma:

Esponjas que son utilizadas en áreas higiénicas deben tener un mínimo de 95% de celdas cerradas, de acuerdo a lo descrito en el acta de la FEIBP. La absorción de agua de nuestras bandas de goma negra especial está bajo el 5%, la absorción de agua de nuestras gomas aprobadas para el manejo de alimentos está incluso bajo el 1%. Las gomas de repuesto caben en todos nuestros haraganes de goma.

4. Mangos:

De aluminio anodizado, fibra de vidrio, plástico, aluminio/plástico y acero recubierto blanco, con el sistema original 8 borde haug octogonal de acoplamiento  son excelentes para una conexión extremadamente fuerte y profesional al equipamiento de limpieza

- ▶ **Uso fácil y efectivo:** introdúcelo, atorníllalo – 100% fijación profesional”

Todos los mangos con “” pueden ser usados con todos los artículos con el símbolo  sin importar el diámetro exterior del mango. Mangos con el sistema haug de acoplamiento son excelentes para una conexión profesional y extremadamente fuerte para el equipamiento de limpieza. Este sistema tiene una resistencia para doblarse de hasta 65 kg. Mangos con daños deben ser cambiados por razones de seguridad. Recomendamos mangos con un diámetro exterior de 25 mm para los artículos de piso desde los 400 mm en adelante.

5. Cuidado y almacenamiento:

A través de nuestros estándares de alta calidad no debe haber ninguna duda sobre los estándares higiénicos de nuestros productos al usarlos en tratamiento térmico y de fluidos. Por favor, preste atención a no poner las cerdas bajo presión mientras estén bajo calor o tratamiento de vapor. Los equipos de limpieza deben ser mantenidos en lugares bien ventilados o suspendidos en closets y rieles sin contacto con el piso o las paredes. Los equipos de limpieza deben reemplazarse si las cerdas están enredadas, deformados, dañadas o desgastadas o si el cuerpo de plástico está dañado.

haug bürsten – tu compañero para la limpieza profesional

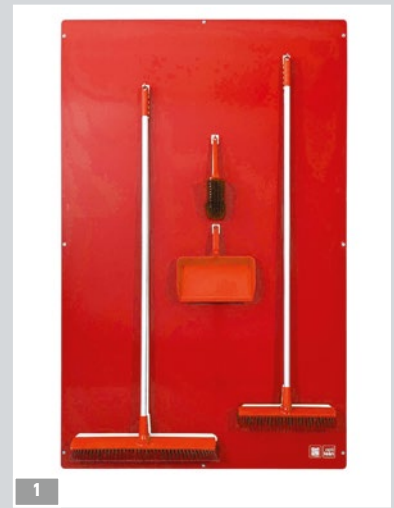

SCHATTENWÄNDE

Schattenwände nach 5S für maximale Hygienesicherheit: Ordnung, Hygiene, Effizienz

In kritischen Bereichen verbinden unsere Schattenwände 5S mit professionellen Reinigungsgeräten zu einem durchgängigen Hygienesystem. Klare Zuordnung senkt Suchzeiten, Verwechslungsrisiken und unterstützt HACCP-Strategien.

Direktdruck, keine Folien, deshalb kein Ablösen möglich: hygienische, widerstandsfähige Oberflächen, langlebige Kennzeichnung. Chemieresistent. Höchste Produkthygiene.

SHADOW BOARDS

Shadow boards according to 5S for maximum hygiene safety: organization, hygiene, efficiency

In critical areas, our shadow boards combine 5S with professional cleaning equipment to form a comprehensive hygiene system. Clear allocation reduces search times, minimizes the risk of confusion and supports HACCP strategies.

Direct printing, no films – therefore no peeling possible: hygienic, durable surfaces with long-lasting labeling. Chemical-resistant. Highest product hygiene.

SUPPORTS MURAUX

Supports muraux selon le 5S pour une sécurité hygiénique maximale: ordre, hygiène, efficacité

Dans les zones critiques, nos supports muraux associent le 5S à des équipements de nettoyage professionnels pour créer un système d'hygiène complet. Une attribution claire réduit les temps de recherche, les risques de confusion et soutient les stratégies HACCP.

Impression directe, sans film – donc aucun décollement possible : surfaces hygiéniques et résistantes avec un marquage durable. Résistants aux produits chimiques. Hygiène des produits maximale.

Individuell angepasst:

- ▶ Anordnung der Reinigungsgeräte, Farbcodierung nach Hygienebereichen, Integration von Piktogrammen/Nummern
- ▶ Raum- und Layoutgerecht

Optionen:

- 1) Schattenwand für die Wandbefestigung
- 2) Mobile Stand-/Rollwagensysteme für flexible Positionierung
- 3) Edelstahl-Einzelschatten
- 4) Selbstklebende Kacheln

Ergebnis: Transparenz, Ordnung, Prozesssicherheit – 5S sichtbar, Hygiene messbar, Prozesse sicher.

Individually customized:

- ▶ Arrangement of cleaning equipment, color coding according to hygiene zones, integration of pictograms/numbers
- ▶ Adapted to room and layout

Options:

- 1) Shadow boards for wall mounting
- 2) Mobile stand/trolley systems for flexible positioning
- 3) Stainless steel individual shadows
- 4) Self-adhesive tiles

Result: transparency, organization, process reliability – 5S made visible, hygiene measurable, processes safe.

Personnalisation individuelle:

- ▶ Disposition des équipements de nettoyage, codage couleur/colour coding selon les zones d'hygiène, intégration de pictogrammes/numéros
- ▶ Adaptés à l'espace et à la configuration

Options:

- 1) Support mural selon à fixer au mur
- 2) Systèmes de supports mobiles ou sur roulettes pour un positionnement flexible
- 3) Ombres individuelles en acier inox
- 4) Carreaux autocollants

Résultat: transparence, ordre, fiabilité des processus – le 5S rendu visible, l'hygiène mesurable, des processus sécurisés.

TABLEROS CON SOMBRAS

Tableros con sombras según 5S para máxima seguridad higiénica: orden, higiene, eficiencia

En áreas críticas, nuestros tableros con sombras combinan 5S con equipos de limpieza profesionales para formar un sistema de higiene integral. Una asignación clara reduce los tiempos de búsqueda, minimiza los riesgos de confusión y apoya las estrategias HACCP.

Impresión directa, sin láminas – por lo tanto sin riesgo de desprendimiento: superficies higiénicas y resistentes con señalización duradera. Resistentes a productos químicos. Máxima higiene del producto.

Personalización individual:

- ▶ Disposición de los equipos de limpieza, codificación por colores según áreas higiénicas, integración de pictogramas/números
- ▶ Adaptados al espacio y al diseño

Opciones:

- 1) Tableros con sombras para montaje en pared
- 2) Sistemas móviles con soporte o carros para una colocación flexible
- 3) Sombras individuales de acero inox
- 4) Baldosas autoadhesivas

Resultado: transparencia, orden, seguridad en los procesos – 5S visible, higiene medible, procesos seguros.



FARBZONEN NACH HACCP

Farbkodierte Reinigungsgeräte sind für die Lebensmittelsicherheit von allerhöchster Bedeutung. Geräte, Bereiche und Prozesse können farblich noch effektiver getrennt werden und das Auftreten von Kreuzkontaminationen deutlich minimieren.

Das Risiko von Produktrückrufen und die damit verbundenen Kosten, werden auf ein Minimum reduziert. Prozesse werden auch dadurch beschleunigt, dass die Reinigungsgeräte nur an dem dafür ausgewiesenen Platz aufbewahrt werden.

Misverständnisse werden vermieden, die Sicherheit erhöht und Mitarbeiter werden ermutigt für die eigenen Geräte noch mehr Verantwortung zu übernehmen. Eine Farbkodierung ist einfach zu verstehen – auch ohne Sprachkenntnisse.

COLOUR CODED ZONES ACCORDING TO HACCP

Colour coded cleaning equipment is of highest importance to food safety. Utensils, areas and processes can be separated more effectively by colour and the occurrence of cross-contamination can be significantly reduced.

The risk of product recalls and the associated costs are reduced to a minimum. Processes are also accelerated by the fact that the cleaning equipment is only kept in the designated space.

Misunderstandings are avoided, security is increased and employees are encouraged to take even more responsibility for their own utensils. Colour coding is easy to understand – even without language skills.

ZONES DE COULEUR SELON L'HACCP

L'équipement de nettoyage à code couleur est d'une grande importance pour la sécurité alimentaire. Les produits, les zones et les processus peuvent être séparés plus efficacement par couleur et l'occurrence de contamination croisée peut être considérablement réduite.

Le risque de rappels de produits et les coûts associés sont réduits au minimum. Les processus sont également accélérés par le fait que l'équipement de nettoyage n'est conservé que dans l'espace désigné. Les malentendus sont évités, la sécurité est renforcée et les employés sont encouragés à assumer encore plus la responsabilité de leurs propres produits. Le codage couleur est facile à comprendre – Et même sans compétences linguistiques.

ZONAS CODIFICADAS POR COLOR SEGÚN HACCP





El equipo de limpieza codificado por colores es de suma importancia para la seguridad alimentaria. Los herramientas de limpieza, las áreas y los procesos se pueden separar de manera más efectiva por color y la contaminación cruzada se puede reducir significativamente.





El riesgo de retiradas de productos y los costes asociados se reducen al mínimo. Los procesos también se aceleran por el hecho de que el equipo de limpieza solo se mantiene en el espacio designado.

Se evitan malentendidos, se aumenta la seguridad y se anima a los empleados a asumir aún más responsabilidad por sus propios herramientas de limpieza. El código de colores es fácil de entender, incluso sin conocimientos de idiomas.

ANWENDUNGSBEREICHE • FIELDS OF APPLICATIONS • DOMAINES D'APPLICATION • CAMPOS DE APLICACIÓN



ANWENDUNGSBEREICHE FIELDS OF APPLICATIONS DOMAINES D'APPLICATION CAMPOS DE APLICACIÓN	PRODUKTE PRODUCTS PRODUITS PRODUCTOS	SEITEN PAGES PAGES PÁGINAS
 <p>Lebensmittelverarbeitende Betriebe food processing industries traitements alimentaires procesadoras de alimentos</p>	<p>Eimer/ buckets/ seaux/ baldes Handschaufeln/ scoops/ pelles à main/ poruñas de mano Mehrzweckgabeln/ utility forks/ fourches alimentaires/ horquetas METAL DETECT basic + METAL DETECT PREMIUM Pinsel/ pastry-brushes/ pinceaux/ brochas para pastelerías Rohrbürsten/ tube-brushes/ écouvillons/ hisopos limpia-tubos Rührlöffel/ paddle-scrapers/ raclettes à cuves/ paletas raspadores Schaber/ scrapers/ racloirs/ raspadores Schaufeln/ shovels/ écopés/ palas Scheuervlies-Pads und Padhalter/ fleece pads and pad holders/ tampons à gratter et raclettes/ pads de fibra y porta pads Schneidebretter/ cutting boards/ planches à découper/ tablas de corte Schwämme/ sponges/ éponges/ esponjas Spachteln, Schaber/ spatulas, scrapers/ spatules, racloirs/ espátulas, raspadores Waschbürsten/ hand-scrub-brushes/ brosses à main/ cepillos de mano para fregar Wasserdurchlaufartikel/ waterchannel articles/ articles passage d'eau/ paso de agua: cepillos y escobillones</p>	<p>50 91 50 122-129 68-69 70-78 86 90 49-50 46-47 92 93 89-90 66-67 22,25,46,61</p>
 <p>Back-Betriebe Baking industries usines à pain et pâtisserie panaderías y pastelerías</p>	<p>Backofenbesen und -bürsten/ oven-brooms and brushes/ balais et brosses pour fours/ escobas y escobillones para horno Bodenschaber/ floor scrapers/ raclettes à sol/ raspadores de piso Brotstreicher/ bread-brushes/ brosses à dorer le pain/ cepillos panaderos Handschaufeln/ scoops/pelles à main/ poruñas de mano Mehlbesen/ flour-brushes/ balayettes à farine/ cepillos para harina Pinsel/ pastry-brushes/ pinceaux à pâtisserie/ brochas para pastelerías Schaber/ scrapers/ racloirs/ raspadores Schneidemaschinenbürsten/ brushes for cutting machines/ brosses pour hachoirs/ cepillos para máquinas de corte Spritztüllenbürsten/ brushes for decorating nozzles/ brosses pour nettoyer des douilles à décorer/ hisopos para boquillas</p>	<p>83-84 29 82 91 82-83 68-69 90 84 77</p>
 <p>Fleischverarbeitende Betriebe meat processing industries entreprises de transformation de viande industrias de procesamiento de carne</p>	<p>Bodenschaber/ floor scrapers/ raclettes à sol/ raspadores de piso Ersatzklingen für Hobel/ refill blades for plane/ recharges lame pour rabot/ hojas de repuesto para recuperador Hackstockbürsten/ chopping block brushes/ brosses pour nettoyer des billots en bois/ raspadores de metal para tablas de corte Hobel/ planes/ rabots/ recuperadores Kesselbürsten/ tank-brushes/ brosses pour tanks/ cepillos para tanque Kutterbürsten/ cutter- brushes/ brosses pour hachoirs/ cepillos para laminadoras Rohrbürsten/ tube-brushes/ écouvillons/ hisopos limpia-tubos Schneidebretter/ cutting boards/ planches à découper/ tablas de corte Waschbürsten/ hand-scrub-brushes/ brosses à main/ cepillos de mano para fregar Wolfbürsten/ turk's head-brush/ brosses cylindriques pour hachoirs et cuves/ hisopo cilíndrico</p>	<p>29 87 87 87,92 85 86 70-78 92 66-67 85</p>
 <p>Getränkehersteller beverages producer fabricant de boissons fabricante de bebidas</p>	<p>Besen/ brooms/ balais/ escobas y escobillones Kehrgarnituren/ dustpan-sets/ pelles et balayettes/ sets de pala+cepillo de mano Schaufeln/ shovels/ écopés/ palas Stielbürsten/ curn brushes/ brosses à manche/ cepillos con mango Wasserschieber/ rubber squeegees/ raclettes sols/ haraganes de goma Wasserschieber mit angespitzter Lippe/ rubber squeegees with bi-injected lip/ raclettes sols avec unilame élastomère/ haraganes de goma de labio bi-injectado Wasch- und Scheuerbürsten/ hand scrub brushes/ brosses à main/ cepillos de mano para fregar Wischer und Schrubber/ wipers and scrubs/ frottoirs/ escobillones, esquineros y cepillos para fregar</p>	<p>19-25 56-59 49-50 60-63 7-13 14 66-67 26-28</p>
 <p>HORECA Hotel, Restaurant, Catering HORECA hotel, restaurant, catering HORECA hôtel, restaurant, catering HORECA hotel, restaurante, catering</p>	<p>Espressomaschinenreinigungssets/ espresso machine cleaning sets/ sets pour nettoyer des machines expresso/ sets de limpieza para máquinas de espresso Padhalter/ pad holders/ raclettes multi-fonctions/ porta pads Rohrbürsten/ tube-brushes/ écouvillons/ hisopos limpia-tubos Scheuervlies-Pads/ fleece pads/ tampons à gratter/ pads de fibra Schneidebretter/ cutting boards/ planches à découper/ tablas de corte Schwämme/ sponges/ éponges/ esponjas Spülbürsten/ dishwashing-brushes/ brosses à vaisselle/ cepillos para lavaplatos Stielbürsten/ churn-brushes/ brosses à manche/ cepillos con mango Tellerabstreifer/ plate- and sink- cleaners/ nettoyeurs pour assiettes et éviers/ limpiador-raspador de platos</p>	<p>73 45-46 70-78 46-47 92 93 79-81 60-63 93</p>

ANWENDUNGSBEREICHE FIELDS OF APPLICATIONS DOMAINES D'APPLICATION CAMPOS DE APLICACIÓN	PRODUKTE PRODUCTS PRODUITS PRODUCTOS	SEITEN PAGES PAGES PÁGINAS
 Bodenreinigung/Bodenpflege floor cleaning/floor care nettoyage des sols/entretien des sols limpieza de pisos/cuidado de piso	Besen/ brooms/ balais/ escobas y escobillones Eimer/ buckets/ seaux/ baldes Fahreimer und Zubehör/ trolleys and accessoires/ chariots de ménage et accessoires/ carros y accesorios Feuchtwischer/ sponge mops/ ensembles lavage de sol/ mopa-esponjas Handbesen und Schaufeln/ hand-brushes and dustpans/ balayettes et pelles/ cepillos y palas de mano Kehrgarnituren/ dustpan-sets/ pelles et balayettes/ sets de pala+cepillo de mano Mopps und Wischbezüge/ mops / balais à franges/ mopas Schaber/ scrapers/ raclettes/ raspadores Teppichkehrer/ carpet-sweepers/ balais mécaniques/ barredoras para alfombra Wasserschieber/ rubber squeegees/ raclettes sols/ haraganes de goma Wischer und Schrubber/ wipers and scrubs/ frottoirs/ escobillones, esquineros y cepillos para fregar	19-25 50 51 29 53-56 56-59 30-31 90 59 7-14 26-28
 Sanitärreinigung sanitary cleaning nettoyages sanitaires limpieza sanitaria	Ausguß-Sauger/ sink-plungers/ aspirateurs d'écoulement/ destapador w.c. con mango plástico Nagelbürsten/ nail-brushes/ brosses à ongles/ escobillas de uñas WC-Bürsten/ toilet-brushes/ brosses à wc/ hisopos para w.c. WC-Garnituren/ toilet-sets/ ensembles wc/ sets para w.c.	105 99-100 101-105 106-109
 Krankenhäuser, Alten- & Pflegeheime hospitals, retirement & nursing homes hôpitaux, maisons de retraite et maisons de repos hospitales, residencias de ancianos y geriátricos	Besen/ brooms/ balais/ escobas y escobillones Fugenbürste/ joint-brushes/ brosses joints/ cepillos articulados Kehrgarnituren mit langem Stiel/ dustpan-sets with long handle/ pelles et balayettes avec manche long/ sets de pala+cepillo de mano con mango largo Klapphalter/ mop holder/ support de lavage/ porta mopa Mopps und Wischbezüge/ mops / balais à franges/ mopas Spülbürsten/ dishwashing-brushes/ brosses à vaisselle/ cepillos para lavaplatos Urinalbürsten/ urinal brushes/ brosses d'urinoir/ cepillos para orinal WC-Bürsten/ toilet-brushes/ brosses à wc/ hisopos para w.c. WC-Garnituren/ toilet-sets/ ensembles wc/ sets para w.c. Wischer und Schrubber/ wipers and scrubs/ frottoirs/ escobillones, esquineros y cepillos para frega	19-25 28,64-65 58-59 30 30-31 79-81 102,105 101-105 106-109 26-28
 Gebäudereinigung & Reinigungs- betriebe, Außenreinigung contract cleaners, exterior cleaning nettoyages des bâtiments, nettoyage extérieur limpieza profesional, limpieza de exteriors	Außenrohrbürsten/ outer-tube-brushes/ brosses pour nettoyer de l'extérieur des tuyau/ hisopos limpia tuberías y exteriores Fahreimer und Zubehör/ trolleys and accessoires/ chariots de ménage et accessoires/ carros y accesorios Fensterwischer/ window-wipers/ raclettes-vitres/ limpia-ventanas IN-UP-Sortiment/ IN-UP-assortment/ IN-UP-assortiment/ variedad IN-UP Jalousienreiniger/ blinds cleaners/ brosses de nettoyage pour stores/ limpia persianas Heizkörperbürsten/ radiator-brushes/ brosses pour radiateurs/ cepillos para radiadores Mopps und Wischbezüge/ mops / balais à franges/ mopas Schaber/ scrapers/ racloirs/ raspadores Scheuervlies-Pads und Padhalter/ fleece pads and pad holders/ tampons à gratter et raclettes/ pads de fibra y porta pads Staubmagnete/ dusters/ époussettes/ cepillos-plumeros Tastaturbürsten/ key-board-brushes/ brosses pour claviers/ cepillos para teclados	45 51 95-97 112-115 96 79 30-31 90 46-47 46 64
 Schwimmbäder swimming pools piscines piscinas	Außenrohrbürsten/ outer-tube-brushes/ brosses pour nettoyer de l'extérieur des tuyau/ hisopos limpia tuberías y exteriores Eckenschrubber/ corner brushes/ balai-brosses d'angle/ cepillos esquineros Kesselbürsten/ tank-brushes/ brosses pour tanks/ cepillos para tanque Staubmagnete/ dusters/ époussettes/ cepillos-plumeros Wasserdurchlaufartikel/ waterchannel articles/ articles passage d'eau/ paso de agua: cepillos y escobillones Wasserschieber/ rubber squeegees/ raclettes sols/ haraganes de goma	45 28 85 46 22,25,46,61 7-14
 Antistatische Sicherheitsbereiche Antistatic security areas Zones de sécurité antistatiques Áreas antiestáticas de seguridad	ESD-Sortiment/ ESD-assortment/ ESD-assortiment/ ESD-variedad	136-139
Problemlöser problem solvers solution aux problèmes solucionadores de problemas	Außenrohrbürsten/ outer-tube brushes/ brosses pour nettoyer de l'extérieur des tuyau/ hisopos limpia tuberías y exteriores Eckenschrubber/ corner brushes/ balai-brosses d'angle/ cepillos esquineros Fugenbürsten/ joint-brushes/ brosses de joint/ cepillos articulados Rohr- und Schlauchbürsten/ tube-and hose-brushes/ écouvillons/ hisopos para mangueras y tubos Staubmagnete/ dusters/ époussettes/ cepillos-plumeros	45 28 28,64-65 70-78 46



098



1102_01
(FC)

1104_01
(FC)



1102_01
(RC)

1104_01
(RC)



Alle Maße sind ca.-Angaben. Änderungen in Form, Farbe und Ausführung bleiben uns vorbehalten.

All measurements are rough values. We subject to change form, colours and design.

Toutes les mesures sont environes. Nous réservons de changer formes, couleurs et qualités.

Todas las medidas son valores aproximados. Nos reservamos el derecho a cambiar de forma, colores y diseño.

IMPRESSUM

Konzept/Gestaltung büro a. WERBUNG & DESIGN | Augsburg | www.bueroa.com

Fotos Hunger & Simmeth | Königsbrunn | www.hungerundsimmeth.de

Druck Druckerei Bayerlein GmbH | Neusäß | www.bayerlein.de

© haug bürsten, Königsbrunn, Germany – Alle Rechte vorbehalten.

Nachdruck, auch auszugsweise, nur mit Zustimmung von haug bürsten.

© All rights served. Reproduction also in part only with the consent of haug bürsten.

© Tous droits réservés. Reproduction également partielle uniquement avec la consentement de haug bürsten.

© Todos los derechos reservados. Reproducción también en parte solo con el consentimiento de haug bürsten.



Geprüft und zertifiziert durch den Europäischen Verband der Bürsten- und Pinselhersteller F.E.I.B.P.

Approved and certified by the European Brushware Federation F.E.I.B.P.

Examiné et certifié par la Fédération Européenne de la Brosserie F.E.I.B.P.

Aprobado y Certificado por la Federación Europea de Cepillos F.E.I.B.P.



Getestet und empfohlen vom Bundesverband der Lebensmittelkontrolleure e.V.

Tested and recommended by the german association for the food quality control

Testé et recommandé par l'association allemande des inspecteurs des denrées alimentaires

Testeado y recomendado por la Asociación Alemana para el Control de Calidad Alimentaria



Gründungsmitglied des „Weinheimer Hygiene-Forum“

Founding member of the „Weinheimer Hygiene-Forum“

Membre fondateur de „Weinheimer Hygiene-Forum“

Miembro fundador del „Weinheimer Hygiene-Forum“



haug® **bürsten**



Made in Germany



haugbuersten KG • Föllstraße 6 • D-86343 Königsbrunn
Telefon (+49) 0 82 31 / 96 30 0 • Fax (+49) 0 82 31 / 96 30 96
office@haugbuersten.de • haugbuersten.de